

Agilent 4291B

RF Impedance/Material Analyzer

Data Sheet

Discontinued Product Information — For Support Reference Only —

Information herein, may refer to products/services no longer supported. We regret any inconvenience caused by obsolete information. For the latest information on Agilent's test and measurement products go to: www.agilent.com/find/products

In the US, call Agilent Technologies at 1-800-829-4444
(any weekday between 8am–5pm in any U.S. time zone)

World-wide Agilent sales office contact information is available at: www.agilent.com/find/contactus

Overview

Specifications describe the instrument's warranted performance over the temperature range of 0°C to 40°C (except as noted). Supplemental characteristics are intended to provide information that is useful in applying the instrument by giving non-warranted performance parameters.

These are denoted as “typical,” “nominal,” or “approximate.” Warm-up time must be greater than or equal to 30 minutes after power on for all specifications. Specifications of the stimulus characteristics and measurement accuracy are defined at the tip of APC-7 connector on the test head connected to the instrument.

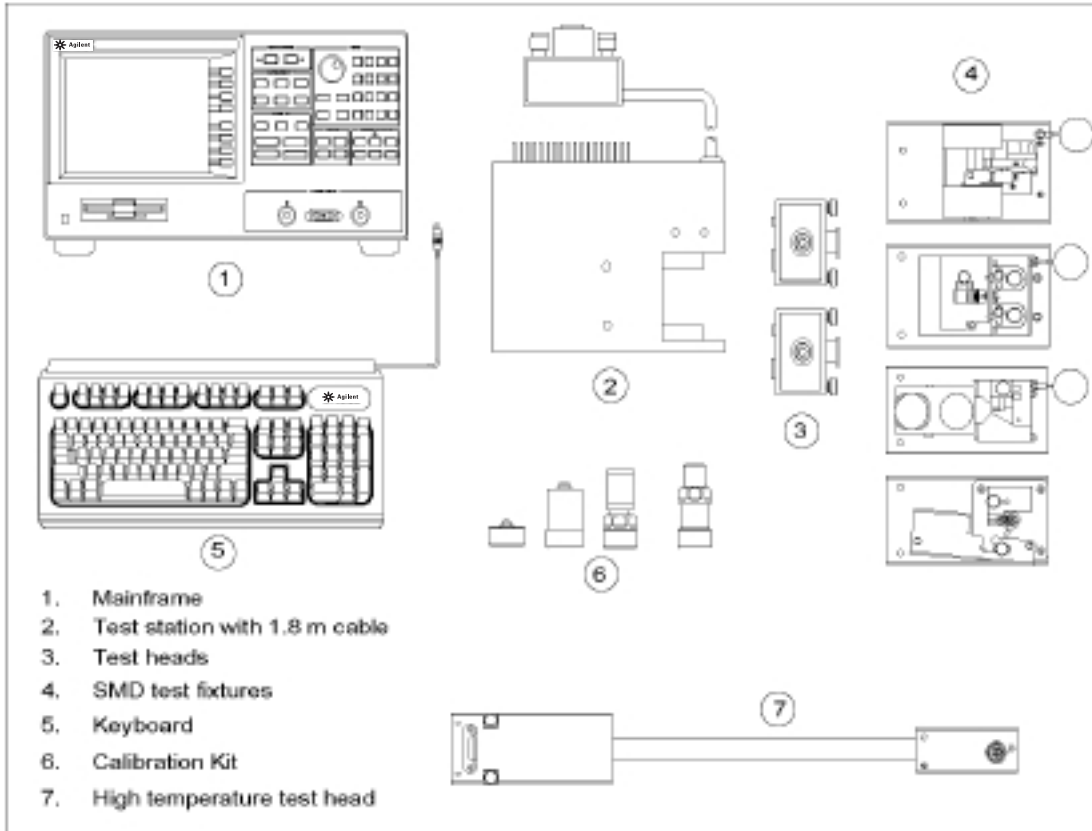

Figure 1-1



Agilent 4291B RF Impedance/Material Analyzer

Measurement Parameters

Impedance parameters

$|Z|$, θ_z , $|Y|$, θ_y , R , X , G , B , C_p , C_s , L_p , L_s , R_p , R_s , D , Q , $|\Gamma|$, θ_y , Γ_x , Γ_y

Stimulus Characteristics

Frequency Characteristics

Operating frequency 1 MHz to 1.8 GHz

Frequency resolution 1 mHz

Frequency reference

Accuracy

@ 23±5°C < ±10 ppm

Precision frequency reference (Option 1D5)

Accuracy

@ 0°C to 40°C < ±1 ppm

Source Characteristics

OSC level

Voltage range

@ 1 MHz ≤ Frequency ≤ 1 GHz (When terminal is open) 0.2 mV_{rms} to 1 V_{rms}

@ 1 GHz < Frequency ≤ 1.8 GHz (When terminal is open) 0.2 mV_{rms} to 0.5 V_{rms}

Current range

@ 1 MHz ≤ Frequency ≤ 1 GHz (When terminal is shorted) 4 μA_{rms} to 20 mA_{rms}

@ 1 GHz < Frequency ≤ 1.8 GHz (When terminal is shorted) 4 μA_{rms} to 10 mA_{rms}

Power range

@ 1 MHz ≤ Frequency ≤ 1 GHz (When terminating with 50 Ω) -67 dBm to 7 dBm

@ 1 GHz < Frequency ≤ 1.8 GHz (When terminating with 50 Ω) -67 dBm to 1 dBm

OSC level resolution

AC voltage resolution

0.22 V_{rms} < V_{OSC} ≤ 1 V_{rms} 2 mV

70 mV_{rms} < V_{OSC} ≤ 220 mV_{rms} 0.5 mV

22 mV_{rms} < V_{OSC} ≤ 70 mV_{rms} 0.2 mV

7 mV_{rms} < V_{OSC} ≤ 22 mV_{rms} 0.05 mV

2.2 mV_{rms} < V_{OSC} ≤ 7 mV_{rms} 0.02 mV

0.7 mV_{rms} < V_{OSC} ≤ 2.2 mV_{rms} 0.005 mV

0.2 mV_{rms} ≤ V_{OSC} ≤ 0.7 mV_{rms} 0.002 mV

Agilent 4291B RF Impedance/Material Analyzer

AC current resolution

4.4 mA _{rms} < I _{OSC} ≤ 20 mA _{rms}	40 μA
1.4 mA _{rms} < I _{OSC} ≤ 4.4 mA _{rms}	10 μA
0.44 mA _{rms} < I _{OSC} ≤ 1.4 mA _{rms}	4 μA
140 μA _{rms} < I _{OSC} ≤ 440 μA _{rms}	1 μA
44 μA _{rms} < I _{OSC} ≤ 140 μA _{rms}	0.4 μA
14 μA _{rms} < I _{OSC} ≤ 44 μA _{rms}	0.1 μA
4 μA _{rms} ≤ I _{OSC} ≤ 14 μA _{rms}	0.04 μA

AC power resolution 0.1 dBm

OSC level accuracy $A + B + \frac{6_{[dB]} \times f_{[MHz]}}{1800}$ dB

where,

A depends on temperature conditions as follows:

- @ within referenced to 23±5°C 2 dB
- @ other environmental temperature conditions 4 dB

B depends on OSC level as follows:

- @ V_{OSC} ≥ 250 mV_{rms} 0 dB
(I_{OSC} ≥ 5 mA_{rms})
(P_{OSC} ≥ -5 dBm)
- @ 250 mV_{rms} > V_{OSC} ≥ 2.5 mV_{rms} 1 dB
(5 mA_{rms} > I_{OSC} ≥ 50 μA_{rms})
(-5 dBm > P_{OSC} ≥ -45 dBm)
- @ other OSC level 2 dB

Definition of OSC level

- Voltage level: 2 × voltage level across the 50 Ω which is connected to the output terminal (This level is approximately equal to the level when a terminal is open.)
- Current level: 2 × current level through the 50 Ω which is connected to the output terminal (This level is approximately equal to the level when a terminal is shorted.)
- Power level: when terminating with 50 Ω

OSC level accuracy 1/2 of specification value (typical)

Connector APC-7

Output impedance 50 Ω (Nominal value)

DC bias (Option 001)

DC voltage level 0 to ±40V

DC current level 20 μA to 100 mA and -20 μA to -100 mA

DC level resolution 1 mV, 20 μA

DC level accuracy

@ 23±5°C

Voltage 0.1 % + 4 mV + (I_{dc [mA]} × 5 [Ω]) mV

Current 0.5 % + 30 μA + (V_{dc [V]} / 10 [kΩ]) mA

@ 8 to 18°C and 28 to 38°C

Voltage 0.2 % + 8 mV + (I_{dc [mA]} × 10 [Ω]) mV

Current 1 % + 60 μA + (V_{dc [V]} / 5 [kΩ]) mA

@ 0 to 8°C and 38 to 40°C

Voltage 0.3 % + 12 mV + (I_{dc [mA]} × 15 [Ω]) mV

Current 1.5 % + 90 μA + (V_{dc [V]} × 3/10 [kΩ]) mA

Agilent 4291B RF Impedance/Material Analyzer

Level monitor

Monitor parameters OSC level (voltage, current), DC bias (voltage, current)

Monitor accuracy

OSC level Same as OSC level accuracy (typical)

DC bias Twice as bad as specifications of dc level accuracy (typical)

Sweep Characteristics

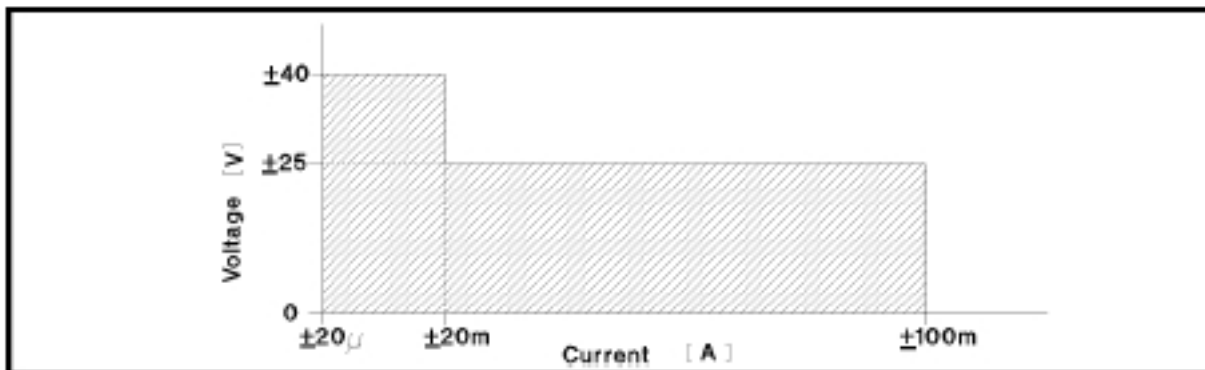

Figure 1-2. DC Voltage and Current Level Range (Typical)

Sweep parameters Frequency, OSC level (voltage), DC bias voltage/current

Sweep setup Start Stop, or Center Span

Sweep type

Frequency sweep Linear, Log, Zero-span, List

Other sweep parameters Linear, Log, Zero-span

Sweep mode Continuous, Single, Manual, Number of groups

Sweep direction

AC level, DC bias (voltage and current) Up sweep, Down sweep

Other sweep parameters Up sweep

Number of measurement points 2 to 801 points

Averaging Sweep average, Point average

Delay time Point delay time, Sweep delay time

Measurement circuit mode Series circuit mode, parallel circuit mode

Calibration/Compensation

Calibration function Open/Short/50 Ω calibration, Low loss calibration

Compensation function Open/Short/Load compensation, Port extension, Electric length

Agilent 4291B RF Impedance/Material Analyzer

Measurement Accuracy

Conditions of accuracy specifications

- Open/Short/50 Ω calibration must be done. Calibration ON.
- Averaging (on point) factor is larger than 32 at which calibration is done if Cal points is set to USER DEF.
- Measurement points are same as the calibration points.
- Environmental temperature is within ±5°C of temperature at which calibration is done, and within 13°C to 33°C. Beyond this environmental temperature condition, accuracy is twice as bad as specified.

$$|Z|, |Y| \text{ Accuracy} \dots\dots\dots \pm(E_a + E_b) [\%]$$

The illustrations of |Z| and |Y| accuracy are shown in Figures 1-3 to 1-6.

$$\theta \text{ Accuracy} \dots\dots\dots \pm \frac{(E_a + E_b)}{100} [\text{rad}]$$

$$\mathbf{L, C, X, B \text{ Accuracy}} \dots\dots\dots \pm(E_a + E_b) \times \sqrt{(1 + D_x^2)} [\%]$$

$$\mathbf{R, G \text{ Accuracy}} \dots\dots\dots \pm(E_a + E_b) \times \sqrt{(1 + Q_x^2)} [\%]$$

D Accuracy (ΔD)

$$@ |D_x \tan\left(\frac{E_a + E_b}{100}\right)| < 1 \dots\dots\dots \pm \frac{(1 + D_x^2) \tan\left(\frac{E_a + E_b}{100}\right)}{1 \mp D_x \tan\left(\frac{E_a + E_b}{100}\right)}$$

$$\text{Especially, @ } D_x \leq 0.1 \dots\dots\dots \pm \frac{(E_a + E_b)}{100}$$

Q Accuracy (ΔQ)

$$@ |Q_x \tan\left(\frac{E_a + E_b}{100}\right)| < 1 \dots\dots\dots \pm \frac{(1 + Q_x^2) \tan\left(\frac{E_a + E_b}{100}\right)}{(1 \mp Q_x) \tan\left(\frac{E_a + E_b}{100}\right)}$$

$$\text{Especially, @ } \frac{10}{(E_a + E_b)} \geq Q_x \geq 10 \dots\dots\dots \pm Q_x^2 \frac{(E_a + E_b)}{100}$$

Where,

D_x : Measured value of D

E_a : depends on measurement frequency as follows:

$$@ 1 \text{ MHz} \leq \text{Frequency} \leq 100 \text{ MHz} \dots\dots\dots 0.6$$

$$@ 100 \text{ MHz} < \text{Frequency} \leq 500 \text{ MHz} \dots\dots\dots 0.8$$

$$@ 500 \text{ MHz} < \text{Frequency} \leq 1000 \text{ MHz} \dots\dots\dots 1.2$$

$$@ 1000 \text{ MHz} < \text{Frequency} \leq 1800 \text{ MHz} \dots\dots\dots 2.0$$

$$E_b = (Z_s / |Z_x| + Y_o |Z_x|) \times 100$$

Q_x : Measured value of Q

Z_x : impedance measurement value [Ω]

Z_s and **Y_o** depend on number of point averaging (N_{av}), OSC level (V_{osc}), impedance measurement value (Z_x) and the test head used as follows:

Agilent 4291B RF Impedance/Material Analyzer

Table 1-1. Z_s and Y_o When High Impedance Test Head Is Used

Measurement Conditions				
Number of Point Averaging (N_{av})	OSC Signal Level (V_{osc})	Meas. Impedance (Z_x)	Z_s [Ω]	Y_o [S]
$1 \leq N_{av} \leq 7$	$V_{osc} < 0.02V$	–	$\frac{0.02}{V_{osc}} \times (0.2 + 0.001 \times f_{[MHz]})$	$\frac{0.02}{V_{osc}} \times (5 \times 10^{-5} + 2 \times 10^{-7} \times f_{[MHz]})$
	$0.02V \leq V_{osc} < 0.12V$	–	$0.2 + 0.001 \times f_{[MHz]}$	$5 \times 10^{-5} + 2 \times 10^{-7} \times f_{[MHz]}$
	$0.12V \leq V_{osc}$	$Z_x \geq 500 \Omega$	$0.2 + 0.001 \times f_{[MHz]}$	$5 \times 10^{-6} + 2 \times 10^{-7} \times f_{[MHz]}$
		$Z_x < 500 \Omega$	$0.2 + 0.001 \times f_{[MHz]}$	$2 \times 10^{-5} + 2 \times 10^{-7} \times f_{[MHz]}$
$N_{av} \geq 8$	$V_{osc} < 0.02V$	–	$\frac{0.02}{V_{osc}} \times (0.1 + 5 \times 10^{-4} \times f_{[MHz]})$	$\frac{0.02}{V_{osc}} \times (2 \times 10^{-5} + 1 \times 10^{-7} \times f_{[MHz]})$
	$0.02V \leq V_{osc} < 0.12V$	–	$0.1 + 5 \times 10^{-4} \times f_{[MHz]}$	$2 \times 10^{-5} + 1 \times 10^{-7} \times f_{[MHz]}$
	$0.12V \leq V_{osc}$	$Z_x \geq 500 \Omega$	$0.1 + 5 \times 10^{-4} \times f_{[MHz]}$	$2 \times 10^{-6} + 1 \times 10^{-7} \times f_{[MHz]}$
		$Z_x < 500 \Omega$	$0.1 + 5 \times 10^{-4} \times f_{[MHz]}$	$7 \times 10^{-6} + 1 \times 10^{-7} \times f_{[MHz]}$

Table 1-2. Z_s and Y_o When Low Impedance Test Head Is Used

Measurement Conditions				
Number of Point Averaging (N_{av})	OSC Signal Level (V_{osc})	Meas. Impedance (Z_x)	Z_s [Ω]	Y_o [S]
$1 \leq N_{av} \leq 7$	$V_{osc} < 0.02V$	–	$\frac{0.02}{V_{osc}} \times (0.1 + 0.001 \times f_{[MHz]})$	$\frac{0.02}{V_{osc}} \times (1 \times 10^{-4} + 2 \times 10^{-7} \times f_{[MHz]})$
	$0.02V \leq V_{osc} < 0.12V$	–	$0.1 + 0.001 \times f_{[MHz]}$	$1 \times 10^{-4} + 2 \times 10^{-7} \times f_{[MHz]}$
	$0.12V \leq V_{osc}$	$Z_x \leq 5 \Omega$	$0.01 + 0.001 \times f_{[MHz]}$	$1 \times 10^{-4} + 2 \times 10^{-7} \times f_{[MHz]}$
		$Z_x > 5 \Omega$	$0.05 + 0.001 \times f_{[MHz]}$	$1 \times 10^{-4} + 2 \times 10^{-7} \times f_{[MHz]}$
$N_{av} \geq 8$	$V_{osc} < 0.02V$	–	$\frac{0.02}{V_{osc}} \times (0.05 + 5 \times 10^{-4} \times f_{[MHz]})$	$\frac{0.02}{V_{osc}} \times (3 \times 10^{-5} + 1 \times 10^{-7} \times f_{[MHz]})$
	$0.02V \leq V_{osc} < 0.12V$	–	$0.05 + 5 \times 10^{-4} \times f_{[MHz]}$	$3 \times 10^{-5} + 1 \times 10^{-7} \times f_{[MHz]}$
	$0.12V \leq V_{osc}$	$Z_x \leq 5 \Omega$	$0.01 + 5 \times 10^{-4} \times f_{[MHz]}$	$3 \times 10^{-5} + 1 \times 10^{-7} \times f_{[MHz]}$
		$Z_x > 5 \Omega$	$0.02 + 5 \times 10^{-4} \times f_{[MHz]}$	$3 \times 10^{-5} + 1 \times 10^{-7} \times f_{[MHz]}$

At the following frequency points, instrument spurious characteristics could occasionally cause measurement errors to exceed specified value because of instrument spurious characteristics.

10.71 MHz	17.24 MHz	21.42 MHz	42.84 MHz
514.645 MHz	686.19333 MHz	1029.29 MHz	1327.38666 MHz

See “EMC” under “Others” in “General Characteristics.”

Agilent 4291B RF Impedance/Material Analyzer

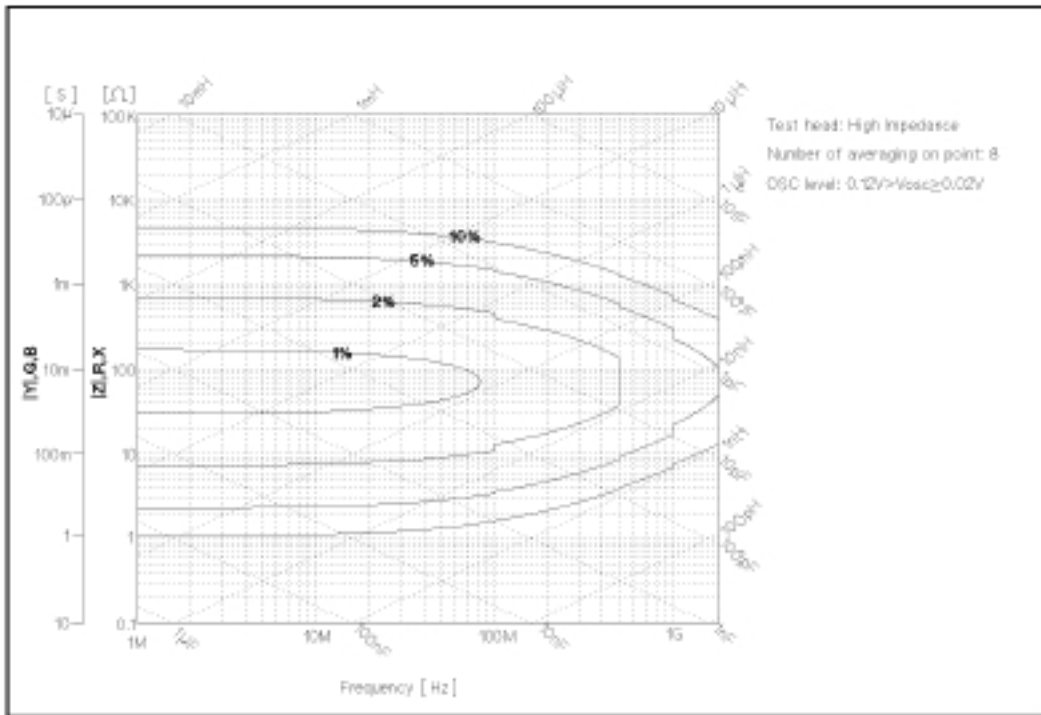

Figure 1-3. Impedance Measurement Accuracy Using High Impedance Test Head (@ Low OSC Level)

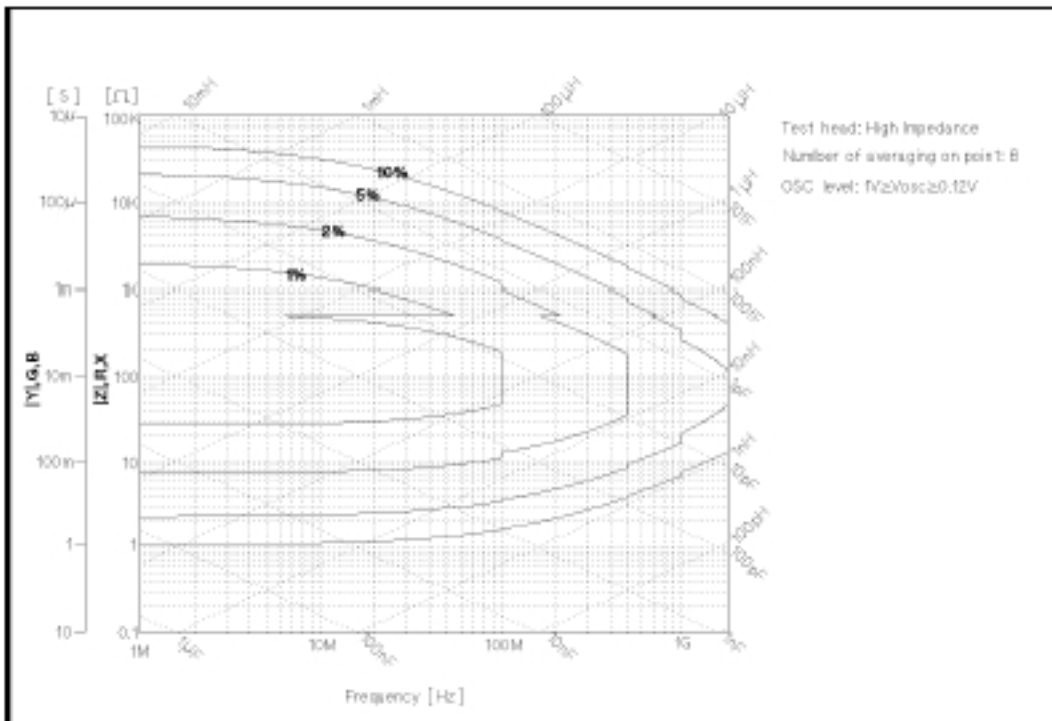

Figure 1-4. Impedance Measurement Accuracy Using High Impedance Test Head (@ High OSC Level)

Agilent 4291B RF Impedance/Material Analyzer

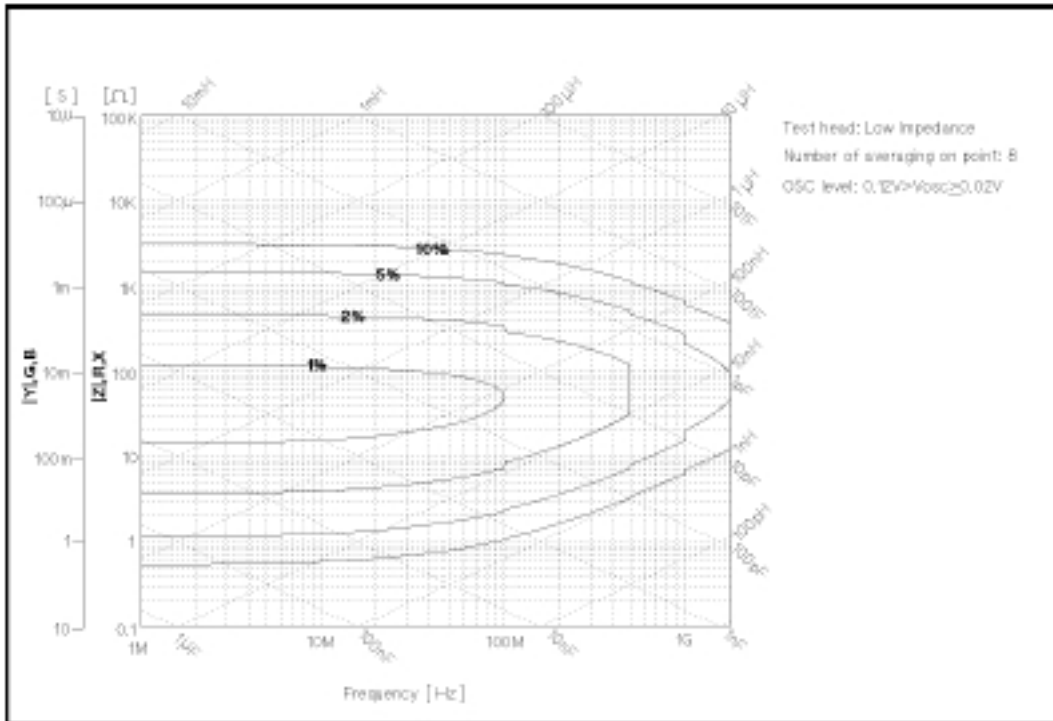

Figure 1-5. Impedance Measurement Accuracy Using Low Impedance Test Head (@ Low OSC Level)

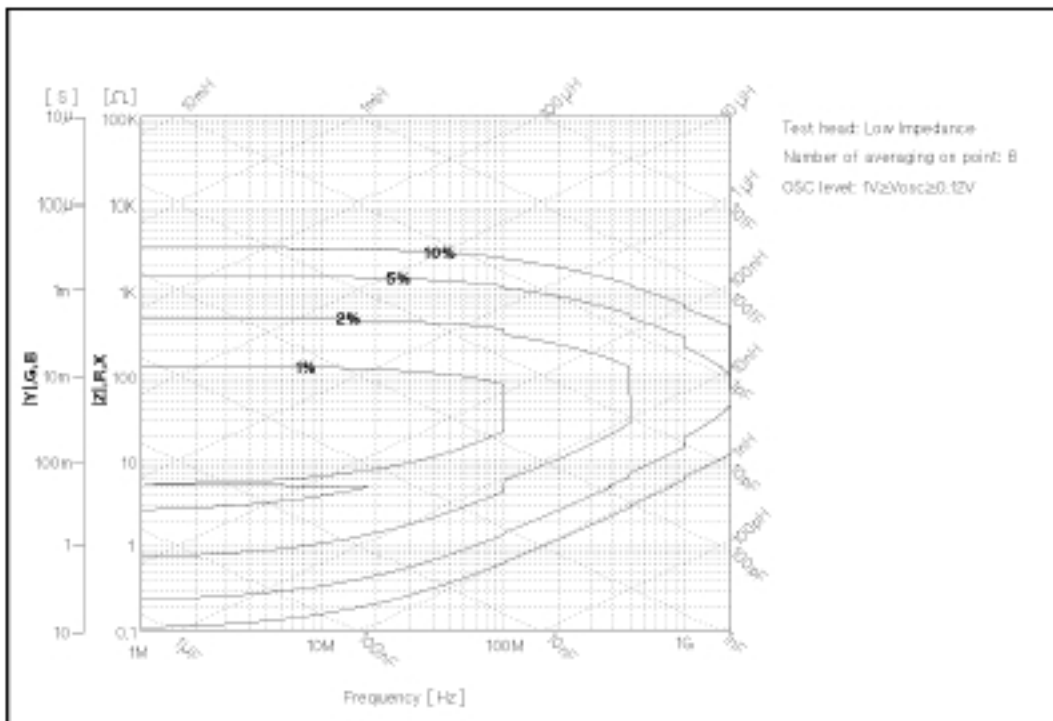

Figure 1-6. Impedance Measurement Accuracy Using Low Impedance Test Head (@ High OSC Level)

Agilent 4291B RF Impedance/Material Analyzer

Typical measurement accuracy when open/short/50 Ω/low-loss-capacitor calibration is done

Conditions

- Averaging on point factor is larger than 32 at which calibration is done.
- Cal Points is set to USER DEF.
- Environmental temperature is within ±5°C of temperature at which calibration is done, and within 13°C to 33°C. Beyond this environmental temperature condition, accuracy is twice as bad as specified.

$$|Z|, |Y| \text{ Accuracy} \dots\dots\dots \pm(E_a + E_b) [\%]$$

$$\theta \text{ Accuracy} \dots\dots\dots \pm \frac{E_c}{100} [\text{rad}]$$

$$L, C, X, B \text{ Accuracy} \dots\dots\dots \pm \sqrt{(E_a + E_b)^2 + (E_c D_x)^2} [\%]$$

$$R, G \text{ Accuracy} \dots\dots\dots \pm \sqrt{(E_a + E_b)^2 + (E_c Q_x)^2} [\%]$$

D Accuracy

$$@ |D_x \tan(E_c/100)| < 1 \dots\dots\dots \pm \frac{(1 + D_x^2) \tan(E_c/100)}{1 + D_x \tan(E_c/100)}$$

$$\text{Especially, } D_x \leq 0.1 \dots\dots\dots \pm \frac{E_c}{100}$$

Q Accuracy

$$@ |Q_x \tan(E_c/100)| < 1 \dots\dots\dots \pm \frac{(1 + Q_x^2) \tan(E_c/100)}{1 + Q_x \tan(E_c/100)}$$

$$\text{Especially, } \frac{10}{E_c} \geq Q_x \geq 10 \dots\dots\dots \pm Q_x^2 \frac{E_c}{100}$$

Where,

D_x : Actual D value of DUT

E_a, E_b : are as same as E_a and E_b of the measurement accuracy when OPEN/SHORT/50 Ω calibration is done.

$$E_c = 0.06 + 0.14 \times \frac{F}{1800} \quad (\text{Typical})$$

F : measurement frequency [MHz]

Q_x : Actual Q value of DUT

Agilent 4291B RF Impedance/Material Analyzer

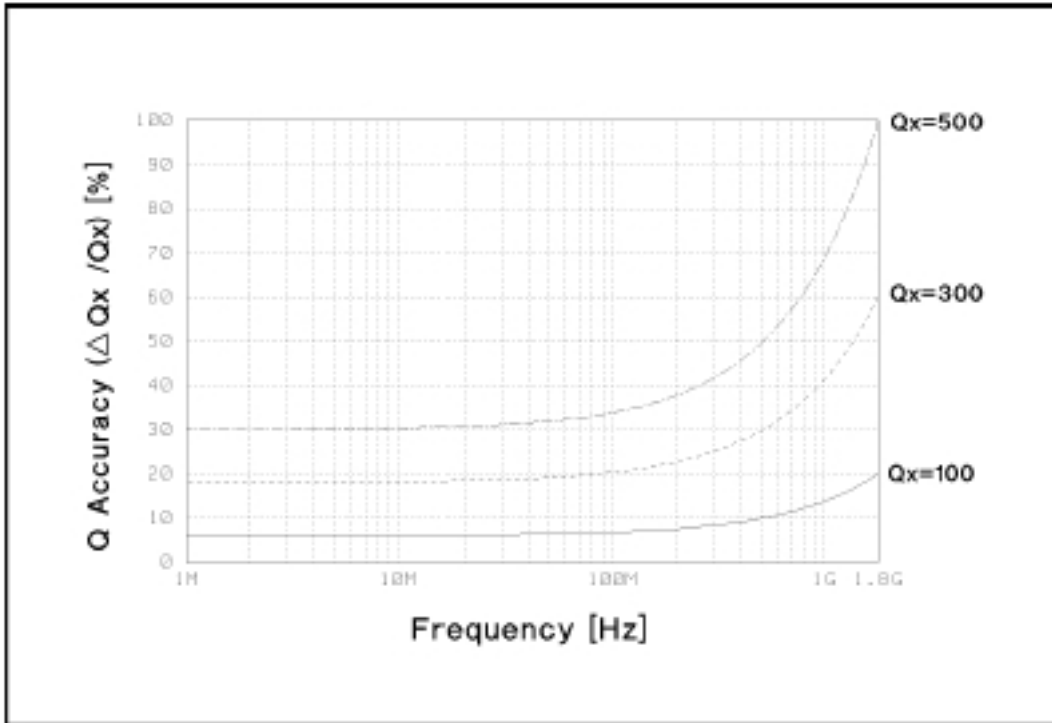

Figure 1-7. Typical measurement accuracy when open/short/50 Ω /low-loss-capacitor calibration is done

Options 013 and 014 High Temperature Test Heads

Specification for Option 013 and 014 High Temperature Test Heads

Frequency Characteristics

Operating frequency 1 MHz to 1.8 GHz

Source Characteristics

OSC level

Voltage Range

@ 1 MHz ≤ Frequency < 1 GHz 0.2 mV_{rms} to 500 mV_{rms}

@ 1 GHz ≤ Frequency ≤ 1.8 GHz 0.2 mV_{rms} 250 mV_{rms}

OSC level resolution

AC voltage resolution

@ 110 mV_{rms} < V_{OSC} ≤ 500 mV_{rms} 2 mV

@ 11 mV_{rms} < V_{OSC} ≤ 110 mV_{rms} 0.2 mV

@ 1.1 mV_{rms} < V_{OSC} ≤ 11 mV_{rms} 20 μV

@ 0.2 mV_{rms} ≤ V_{OSC} ≤ 1.1 mV_{rms} 2 μV

AC current resolution

@ 2.75 mA_{rms} < I_{OSC} ≤ 12.5 mA_{rms} 50 μA

@ 0.275 mA_{rms} < I_{OSC} ≤ 2.75 mA_{rms} 5 μA

@ 27.5 μA_{rms} < I_{OSC} ≤ 275 μA_{rms} 0.5 μA

@ 5 μA ≤ I_{OSC} ≤ 27.5 μA 0.05 μA

AC power resolution

@ -66.1 dBm ≤ P_{OSC} ≤ 1.9 dBm 0.2 dBm max

OSC level accuracy

@ 1 MHz ≤ Frequency ≤ 1 GHz, V_{OSC} ≤ 0.25 V_{rms} (I_{OSC} ≤ 6.3 mA, P_{OSC} ≤ -4.1 dBm)

. $A + B + \frac{8[\text{dB}] \times \text{frequency}[\text{MHz}]}{1800} \text{ dB}$

Where,

A depends on temperature conditions as follows:

within referenced to 23±5°C 4 dB

@ 0°C to 18°C, 28°C to 40°C 6 dB

B depends on OSC level as follows:

@ 0.5 V_{rms} ≥ V_{OSC} ≥ 120 mV_{rms} 0 dB

(12.5 mA_{rms} ≥ I_{OSC} ≥ 3 mA_{rms})

(1.9 dBm ≥ P_{OSC} ≥ -10 dBm)

@ 120 mV_{rms} > V_{OSC} ≥ 1.2 mV_{rms} 1 dB

(3 mA_{rms} > I_{OSC} ≥ 30 μA_{rms})

(-10 dBm > P_{OSC} ≥ -50 dBm)

@ 1.2 mV_{rms} > V_{OSC} ≥ 0.2 mV_{rms} 2 dB

(30 μA_{rms} > I_{OSC} ≥ 5 μA_{rms})

(-50 dBm > P_{OSC} ≥ -66.1 dBm)

Output impedance 40 Ω (Nominal value)

Level Monitor

Monitor accuracy

OSC level Same as OSC level accuracy (typical)

DC bias Twice as bad as specifications of dc level accuracy (typical)

Options 013 and 014 High Temperature Test Heads

Basic Measurement Accuracy

Conditions of accuracy specifications

- OPEN/SHORT/50 Ω calibration must be done. Calibration ON.
- Averaging (on point) factor must be larger than 32 at which calibration is done.
- Measurement points are same as the calibration points.
- Environmental temperature is within $\pm 5^{\circ}\text{C}$ of temperature at which calibration is done, and within 13°C to 33°C . Beyond this environmental temperature condition, and within 0°C to 40°C , accuracy is twice as bad as specified.
- Bending cable should be smooth and the bending angle is less than 30° .
- Cable position should be kept in the same position after calibration measurement.
- OSC level must be same as level at which calibration is done.
- OSC level is less than or equal to 0.25 V, or OSC level is greater than 0.25 V and frequency range is within 1 MHz to 1 GHz.

$$|Z| \text{ Accuracy} \dots\dots\dots \pm(E_a + E_b) [\%]$$

$$\theta \text{ Accuracy} \dots\dots\dots \pm \frac{(E_a + E_b)}{100} [\text{rad}]$$

Where,

E_a : depends on measurement frequency as follows:

- @ 1 MHz \leq frequency \leq 100 MHz $\dots\dots\dots$ 0.6 [%]
- @ 100 MHz $<$ frequency \leq 500 MHz $\dots\dots\dots$ 0.8 [%]
- @ 500 MHz $<$ frequency \leq 1 GHz $\dots\dots\dots$ 1.5 [%]
- @ 1 GHz $<$ frequency \leq 1.8 GHz $\dots\dots\dots$ 3.0 [%]

$$E_b = (Z_s/Z_x + Y_o Z_x) \times 100 [\%]$$

Z_s and Y_o depend on number of point averaging (N_{av}) and OSC level (V_{osc}) as follows:

Z_x : Impedance measurement value [Ω]

Options 013 and 014 High Temperature Test Heads

Table 1-3. Z_s and Y_o When High Impedance Test Head Is Used

Measurement Conditions			
Number of Point Averaging (N_{av})	OSC Signal Level (V_{osc}) ¹	Z_s [Ω]	Y_o [S]
$1 \leq N_{av} \leq 7$	$V_{osc} < 0.02$	$\frac{0.02}{V_{osc}} \times (0.2 + 0.001 \times f_{[MHz]})$	$\frac{0.02}{V_{osc}} \times (5 \times 10^{-5} + 2 \times 10^{-7} \times f_{[MHz]})$
	$0.02V \leq V_{osc} < 0.12$	$0.2 + 0.001 \times f_{[MHz]}$	$5 \times 10^{-5} + 2 \times 10^{-7} \times f_{[MHz]}$
	$0.12V \leq V_{osc}$	$0.2 + 0.001 \times f_{[MHz]}$	$3 \times 10^{-6} + 2 \times 10^{-7} \times f_{[MHz]}$
$8 < N_{av}$	$V_{osc} < 0.02$	$\frac{0.02}{V_{osc}} \times (0.1 + 0.001 \times f_{[MHz]})$	$\frac{0.02}{V_{osc}} \times (2 \times 10^{-5} + 2 \times 10^{-7} \times f_{[MHz]})$
	$0.02V \leq V_{osc} < 0.12$	$0.1 + 0.001 \times f_{[MHz]}$	$2 \times 10^{-5} + 2 \times 10^{-7} \times f_{[MHz]}$
	$0.12V \leq V_{osc}$	$0.1 + 0.001 \times f_{[MHz]}$	$2 \times 10^{-5} + 2 \times 10^{-7} \times f_{[MHz]}$

1. $V_{osc} = 0.12V \equiv I_{osc} = 3 \text{ mA} \equiv P_{osc} = -10 \text{ dBm}$, $V_{osc} = 0.02V \equiv I_{osc} = 0.5 \text{ mA} \equiv P_{osc} = -26 \text{ dBm}$

Table 1-4. Z_s and Y_o When Low Impedance Test Head Is Used

Measurement Conditions			
Number of Point Averaging (N_{av})	OSC Signal Level (V_{osc}) ¹	Z_s [Ω]	Y_o [S]
$1 \leq N_{av} \leq 7$	$V_{osc} < 0.02$	$\frac{0.02}{V_{osc}} \times (0.1 + 0.001 \times f_{[MHz]})$	$\frac{0.02}{V_{osc}} \times (1 \times 10^{-4} + 2 \times 10^{-7} \times f_{[MHz]})$
	$0.02V \leq V_{osc} < 0.12$	$0.1 + 0.001 \times f_{[MHz]}$	$1 \times 10^{-4} + 2 \times 10^{-7} \times f_{[MHz]}$
	$0.12V \leq V_{osc}$	$0.05 + 0.001 \times f_{[MHz]}$	$1 \times 10^{-4} + 2 \times 10^{-7} \times f_{[MHz]}$
$8 < N_{av}$	$V_{osc} < 0.02$	$\frac{0.02}{V_{osc}} \times (0.05 + 0.001 \times f_{[MHz]})$	$\frac{0.02}{V_{osc}} \times (3 \times 10^{-5} + 2 \times 10^{-7} \times f_{[MHz]})$
	$0.02V \leq V_{osc} < 0.12$	$0.05 + 0.001 \times f_{[MHz]}$	$3 \times 10^{-5} + 2 \times 10^{-7} \times f_{[MHz]}$
	$0.12V \leq V_{osc}$	$0.03 + 0.001 \times f_{[MHz]}$	$3 \times 10^{-5} + 2 \times 10^{-7} \times f_{[MHz]}$

1. $V_{osc} = 0.12V \equiv I_{osc} = 3 \text{ mA} \equiv P_{osc} = -10 \text{ dBm}$, $V_{osc} = 0.02V \equiv I_{osc} = 0.5 \text{ mA} \equiv P_{osc} = -26 \text{ dBm}$

At the following frequency points, instrument spurious characteristics could occasionally cause measurement errors to exceed specified value because of instrument spurious characteristics.

10.71 MHz	17.24 MHz	21.42 MHz	42.84 MHz
514.645 MHz	686.19333 MHz	1029.29 MHz	1327.38666 MHz

See “EMC” under “Others” in “General Characteristics.”

The excessive vibration and shock could occasionally cause measurement errors to exceed specified values.

Options 013 and 014 High Temperature Test Heads

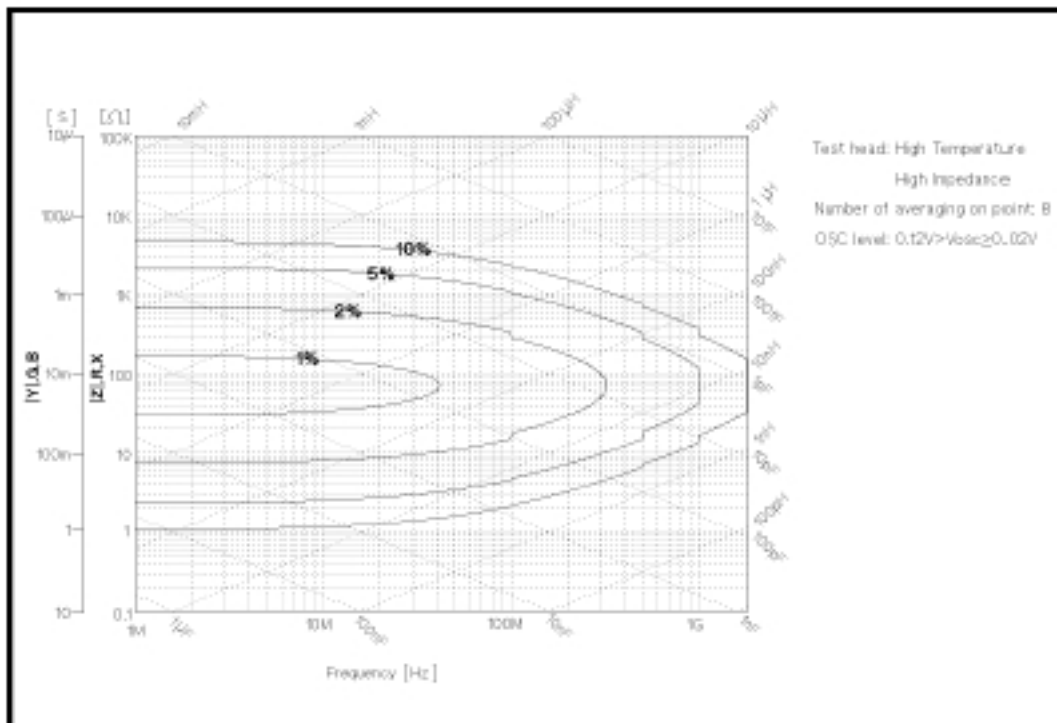

Figure 1-8. Impedance Measurement Accuracy Using High Temperature High Impedance Test Head (@ Low OSC Level)

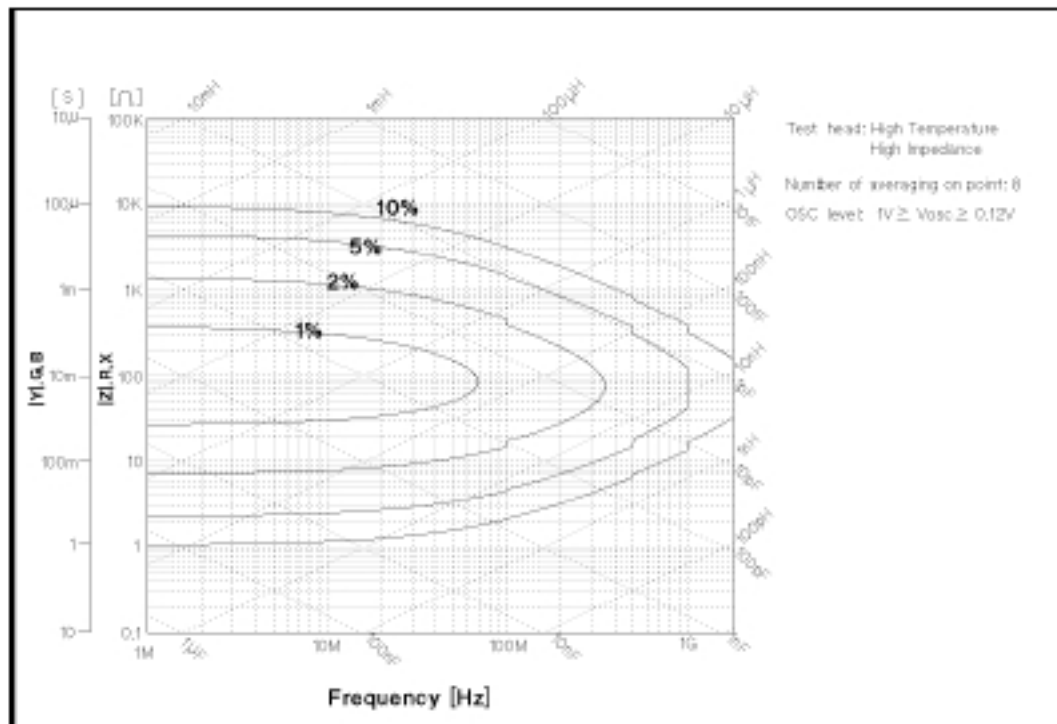

Figure 1-9. Impedance Measurement Accuracy Using High Temperature High Impedance Test Head (@ High OSC Level)

Options 013 and 014 High Temperature Test Heads

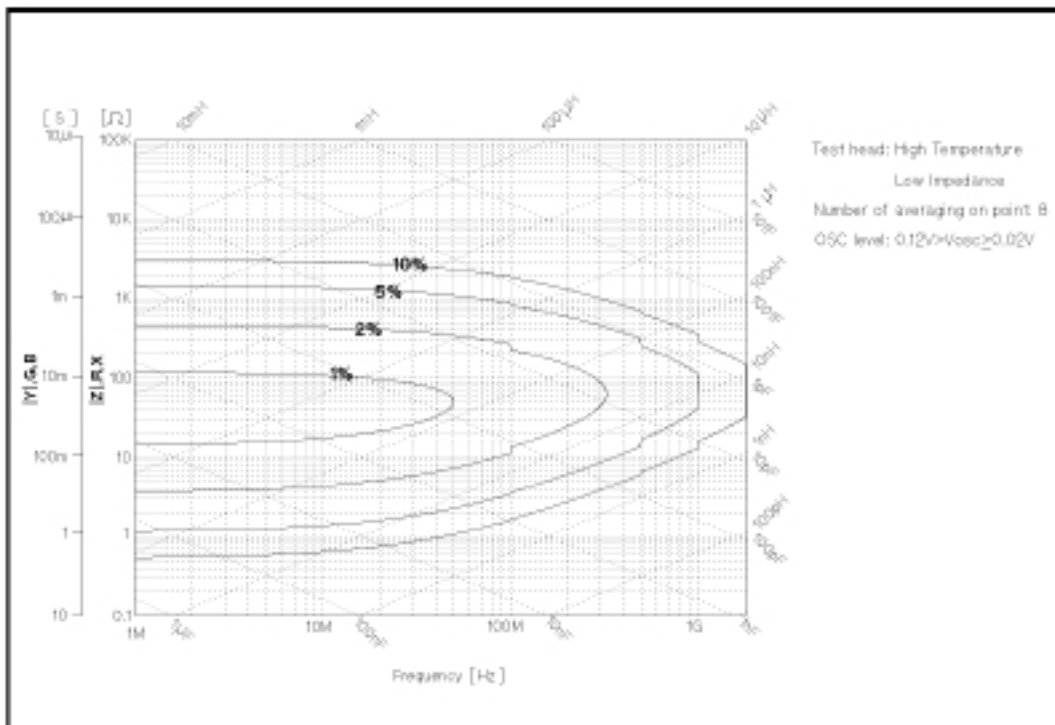

Figure 1-10. Impedance Measurement Accuracy Using High Temperature Low Impedance Test Head (@ Low OSC Level)

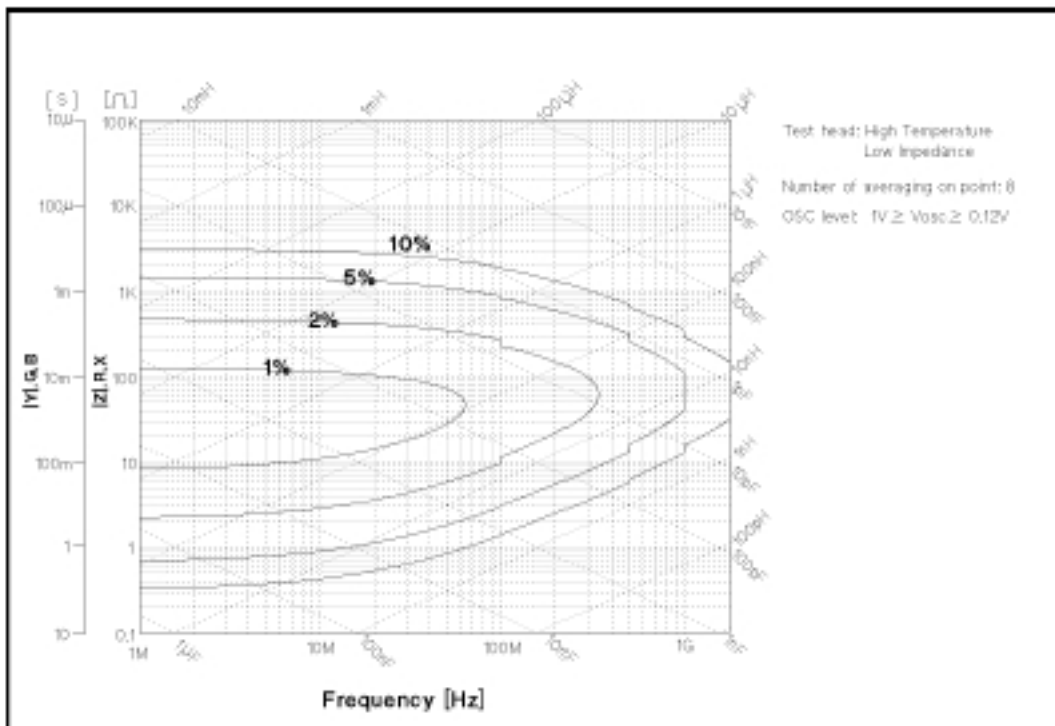

Figure 1-11. Impedance Measurement Accuracy Using High Temperature Low Impedance Test Head (@ High OSC Level)

Options 013 and 014 High Temperature Test Heads

Typical Effects of Temperature Drift on Measurement Accuracy

When environmental temperature exceeds $\pm 5^{\circ}\text{C}$ of temperature at which calibration is done, add the following measurement error.

Conditions of typical effects of temperature drift

- Environment temperature of a test head is within -55°C to 0°C or 40°C to 200°C .
- Environment temperature of the mainframe is within $\pm 5^{\circ}\text{C}$ of temperature at which calibration is done, and within 0°C to 40°C .
- Other conditions are as same as the conditions of the basic measurement accuracy of Option 013/014.

$$|Z| \text{ Accuracy} \dots\dots\dots \pm(E_{a2} + E_{b2}) [\%]$$

$$\theta \text{ Accuracy} \dots\dots\dots \pm \frac{(E_{a2} + E_{b2})}{100} [\text{rad}]$$

Where,

$$E_{a2} = (\Delta A_1 \Delta T + \Delta A_2) \times 10^8$$

$$E_{b2} = (Z_{s2}/Z_x + Y_{o2} Z_x) \times 100$$

ΔA_1 is the effect of temperature drift on the impedance measurement value as follows:

$$(50 + 300 \times f) [\text{ppm}/^{\circ}\text{C}] \text{ (typical)}$$

ΔA_2 is the hysteresis of the effect of temperature drift on the impedance measurement value as follows:

$$\frac{\Delta A_1 \Delta T}{3} [\text{ppm}] \text{ (typical)}$$

f : Measurement Frequency [GHz]

ΔT : Difference of temperature between measurement condition and calibration measurement condition. [$^{\circ}\text{C}$]

$$Y_{o2} = (\Delta Y_{o1} \Delta T + \Delta Y_{o2}) \times 10^{-6} [\text{S}]$$

$$Z_{s2} = (\Delta Z_{s1} \Delta T + \Delta Z_{s2}) \times 10^{-3} [\Omega]$$

Z_x : Impedance measurement value [Ω]

Y_{o1} is the temperature coefficient for OPEN residual as follows:

@ High Temperature High Impedance Test Head is used $\dots\dots\dots (0.2 + 8 \times f^2) [\mu\text{S}/^{\circ}\text{C}] \text{ (typical)}$

@ High Temperature Low Impedance Test Head is used $\dots\dots\dots (1 + 30 \times f) [\mu\text{S}/^{\circ}\text{C}] \text{ (typical)}$

Y_{o2} is the hysteresis of the OPEN residual as follows: $\dots\dots\dots \frac{\Delta Y_{o1} \Delta T}{3} [\mu\text{S}/^{\circ}\text{C}] \text{ (typical)}$

ΔZ_{s1} is the temperature coefficient for SHORT residual as follows:

@ High Temperature High Impedance Test Head is used $\dots\dots\dots (4 + 50 \times f) [\text{m}\Omega/^{\circ}\text{C}] \text{ (typical)}$

@ High Temperature Low Impedance Test Head is used $\dots\dots\dots (1 + 10 \times f^2) [\text{m}\Omega/^{\circ}\text{C}] \text{ (typical)}$

ΔZ_{s2} is the hysteresis of the SHORT residual as follows: $\dots\dots\dots \frac{\Delta Z_{s1} \Delta T}{3} [\text{m}\Omega/^{\circ}\text{C}] \text{ (typical)}$

Options 013 and 014 High Temperature Test Heads

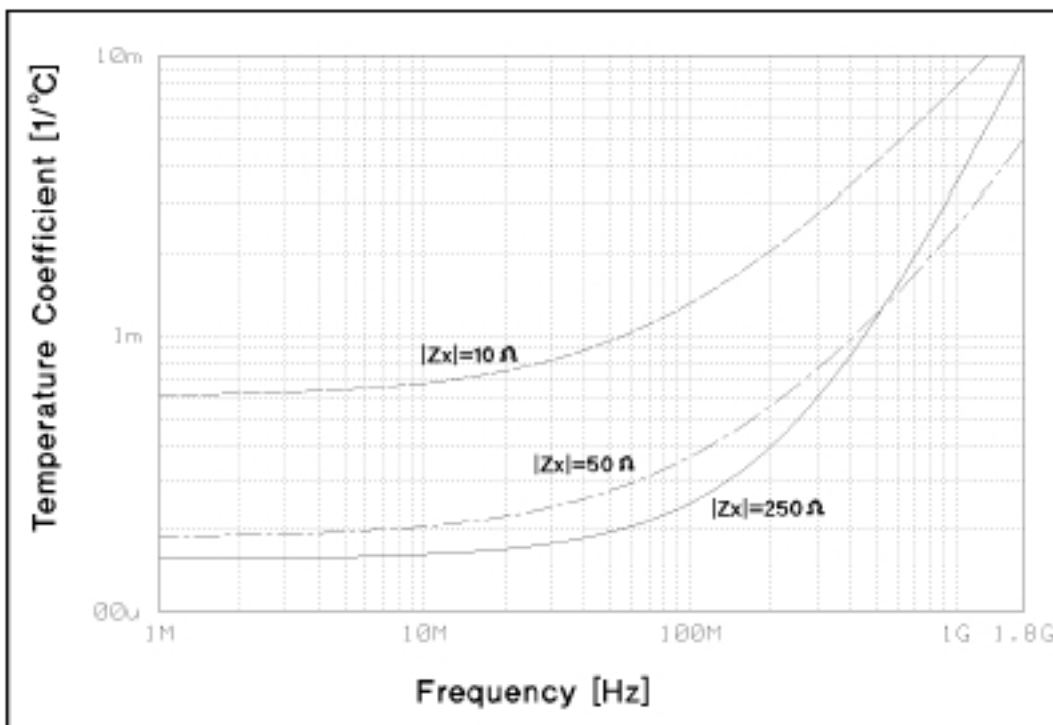

Figure 1-12. Typical Frequency Characteristics of Temperature Coefficient Using High Temperature High Impedance Test Head

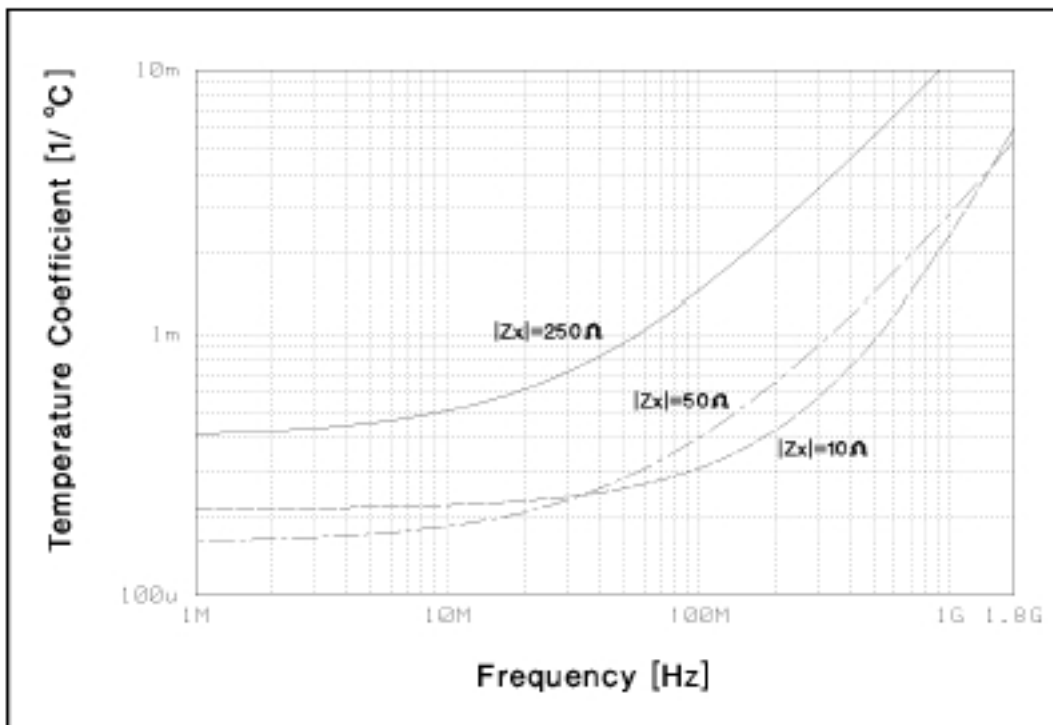

Figure 1-13. Typical Frequency Characteristics of Temperature Coefficient Using High Temperature Low Impedance Test Head

Options 013 and 014 High Temperature Test Heads

Operation Conditions of the Test Head

- The cable must be at the same temperature as the main frame at least 15 cm from the test station.
..... 55°C to +200°C

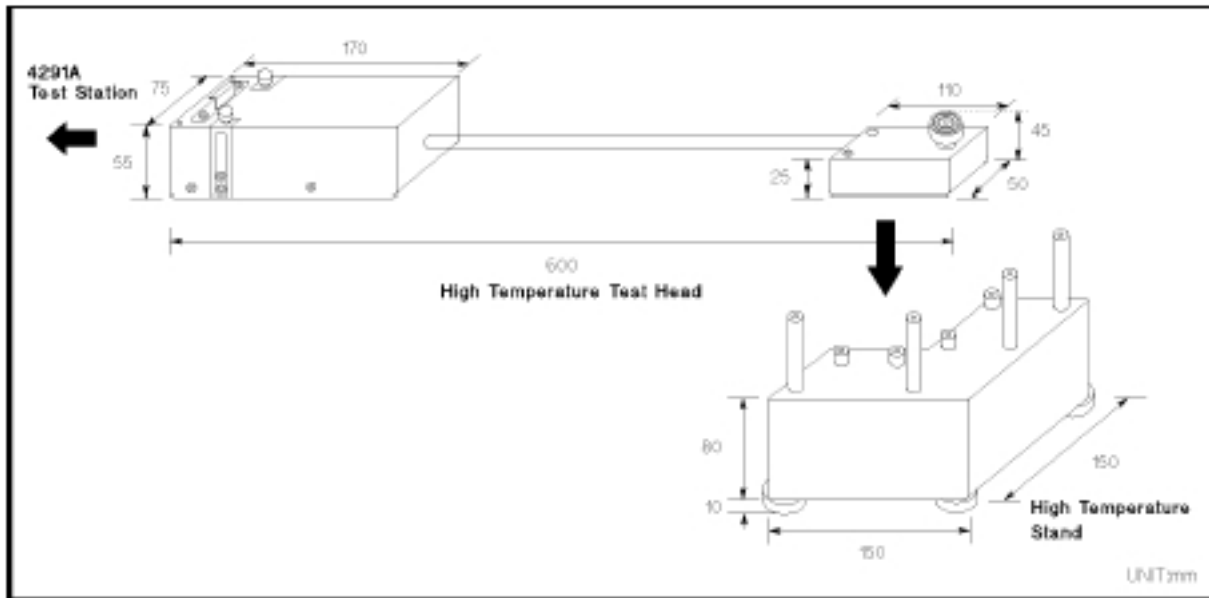

Figure 1-14. Dimensions of High Temperature Test Head

Options 013 and 014 High Temperature Test Heads

Display

LCD

Type/size	Color TFT, 8.4 inch
Resolution	640 × 480
Effective Display Area	160 mm × 115 mm (600 × 430 dots)
Number of display channels	2
Format	single, dual split or overwrite, graphic, and tabular
Number of traces	
For measurement	1 trace/channel
For memory	16 traces/channel (maximum)
Data math functions	gain × data-offset gain × memory - offset gain × (data - memory) - offset gain × (data + memory) - offset gain × (data/memory) - offset gain × (data × memory) - offset

Marker

Number of markers

Main marker	1 for each channel
Sub-marker	7 for each channel
ΔMarker	1 for each channel

Data Storage

Type	floppy disk drive, Volatile memory disk
Capacity	
floppy disk	720 kB/1.44 MB
Volatile memory disk, can be backed up by flash memory	448 kB (maximum)
Disk format	LIF, DOS

GPIB

Interface	IEEE 488.1-1987, IEC625
Interface function	SH1, AH1, T6, TE0, L4, LE0, SR1, RL1, PPO, DC1, DT1, C1, C2, C3, C4, C11, E2
Numeric Data Transfer formats	ASCII 32 and 64 bit IEEE 754 Floating point format, DOS PC format (32 bit IEEE with byte order reversed)
Protocol	IEEE 488.2-1987

Options 013 and 014 High Temperature Test Heads

Printer Parallel Port

Interface IEEE 1284 Centronics standard compliant
 Printer control language HP PCL3 Printer Control Language
 Connector D-sub (25-pin)

General Characteristics

Input and Output Characteristics

External reference input

Frequency 10 MHz \pm 100 Hz (typically)
 Level > -6 dBm (typically)
 Input impedance 50 Ω (nominal)
 Connector BNC female

Internal Reference Output

Frequency 10 MHz (nominal)
 Level 2 dBm (typically)
 Output impedance 50 Ω (nominal)
 Connector BNC female

External trigger input

Level TTL Level
 Pulse width (T_p) > 2 μ s (typically)
 Polarity positive/negative selective
 Connector BNC female

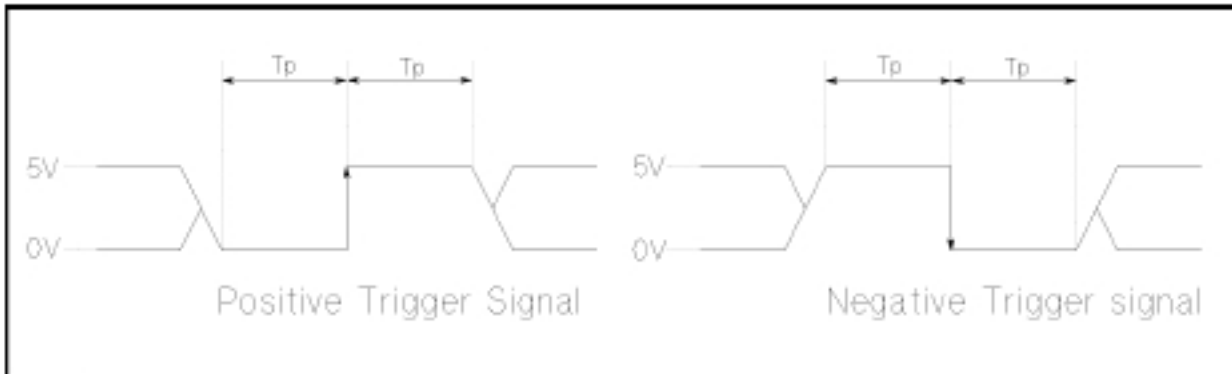

Figure 1-15. Trigger Signal

External monitor output

Connector D-sub (15-pin HD)
 Display resolution 640 \times 480 VGA

Options 013 and 014 High Temperature Test Heads

Operation Conditions

Temperature

Disk drive non-operating condition 0°C to 40°C
Disk drive operating condition 10°C to 40°C

Humidity

@ wet bulb temperature <29°C, without condensation

Disk drive non-operating condition 15 % to 95 % RH
Disk drive operating condition 15 % to 80 % RH

Altitude 0 to 2,000 meters

Warm-up time 30 minutes

Non-operation conditions

Temperature -20°C to 60°C

Humidity

@ wet bulb temperature <45°C, without condensation 15 % to 95 % RH

Altitude 0 to 4,572 meters

Others

EMC Complies with CISPR 11 (1990) / EN 55011 (1991) : Group 1, Class A
..... Complies with IEC 1000-3-2 (1995) / EN 61000-3-2 (1995)
..... Complies with IEC 1000-3-3 (1994) / EN 61000-3-3 (1995)
..... Complies with IEC 1000-4-2 (1995) / EN 50082-1 (1992) : 4 kV CD, 8 kV AD
..... Complies with IEC 1000-4-2 (1995) / EN 50082-1 (1992) : 3 V/m
..... Complies with IEC 1000-4-4 (1995) / EN 50082-1 (1992) : 1 kV / Main, 0.5k V / Signal Line

Note: When tested at 3 V/m according to IEC 1000-4-3 (1995), the measurement accuracy will be within specifications over the full immunity test frequency range of 27 to 1000 MHz except when the analyzer frequency is identical to the transmitted interference signal test frequency.

Safety Complies with IEC 1010-1 (1990), Amendment 1 (1992) and Amendment 2 (1995).
..... Complies with CSA-C22.2 No. 1010.1-92.

Power requirements 90V to 132V, or 198V to 264V (automatically switched), 47 to 63 Hz, 300VA max

Weight

Mainframe 21.5 kg (SPC)
Test Station 3.7 kg

Dimensions

Mainframe 425 (W) × 235 (H) × 553 (D) mm
Test Station 275 (W) × 95 (H) × 205 (D) mm

Options 013 and 014 High Temperature Test Heads

External Program Run/Cont Input

Connector BNC female
Level TTL
Keyboard connector mini-DIN
I/O port 4 bit in/ 8 bit out port, TTL Level

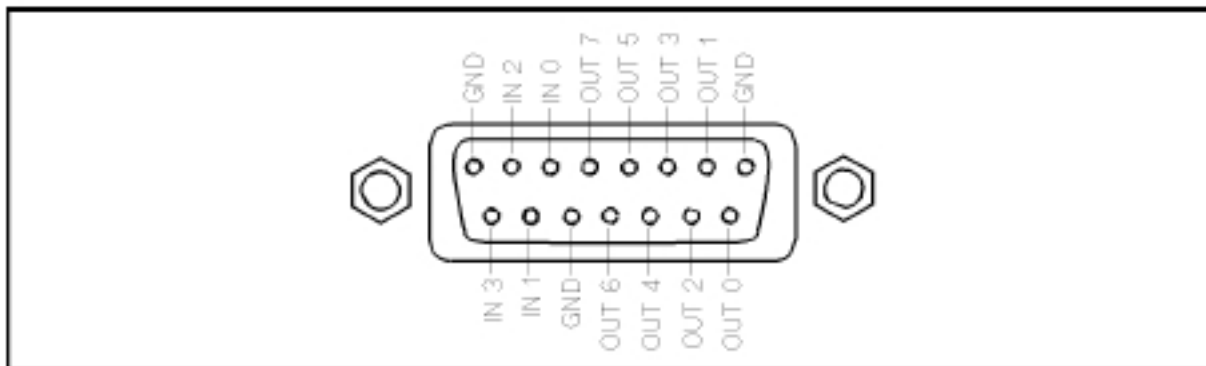

Figure 1-16. I/O Port Pin Assignment

Specifications for Option 1D5 High Stability Frequency Reference

Reference Oven Output

Frequency 10 MHz (nominal)
Level 0 dBm (typically)
Output Impedance 50 Ω (nominal)
Connector BNC female

Option 002 Material Measurement

Supplemental Characteristics for Option 002 Material Measurement

Measurement Frequency Range

Using the Agilent 16453A	1 MHz to 1.0 GHz (Typical)
Using the Agilent 16454A	1 MHz to 1.0 GHz (Typical)

Measurement Parameters

Permittivity parameters	$ \epsilon_r , \epsilon_r', \epsilon_r'', \tan\delta$
Permeability parameters	$ \mu_r , \mu_r', \mu_r'', \tan\delta$

Typical Measurement Accuracy

Conditions of accuracy characteristics

- Use the High Z Test Head for permittivity measurement
- Use the Low Z Test Head for permeability measurement
- OPEN/SHORT/50 Ω calibration must be done. Calibration ON.
- Averaging (on point) factor is larger than 32 at which calibration is done if Cal points is set to USER DEF.
- Measurement points are same as the calibration points if Cal point is set to USER DEF.
- Environment temperature is within $\pm 5^\circ\text{C}$ of temperature at which calibration is done, and within 13°C to 33°C . Beyond this environmental temperature condition, accuracy is twice as bad as specified.

ϵ_r' Accuracy ($\frac{\Delta\epsilon_{rm}'}{\epsilon_{rm}'}$)

$$@ \tan\delta < 0.1 \dots\dots\dots 5 + (10 + \frac{0.04}{f}) \frac{t}{\epsilon_{rm}'} + 0.25 \frac{\epsilon_{rm}'}{t} + \frac{100}{|1 - (13/\sqrt{\epsilon_{rm}'/f})^2|} [\%] \text{ (Typical)}$$

Loss Tangent Accuracy of ϵ_r^A ($\Delta\tan\delta$)

$$@ \tan\delta < 0.1 \dots\dots\dots E_a + E_b \text{ (Typical)}$$

Where,

@ frequency ≤ 1 GHz

$$E_a = 0.002 + \frac{0.0004}{f} \frac{t}{\epsilon_m'} + 0.004f + \frac{0.1}{|1 - (13/\sqrt{\epsilon_{rm}'/f})^2|} \text{ (Typical)}$$

@ frequency > 1 GHz

$$E_a = 0.002 + \frac{0.0004}{f} \frac{t}{\epsilon_m'} + 0.004f + \frac{0.1}{|1 - (13/\sqrt{\epsilon_{rm}'/f})^2|} \text{ (Typical)}$$

$$E_b = (\frac{\Delta\epsilon_{rm}'}{\epsilon_{rm}'} \frac{1}{100} + \epsilon_{rm}' \frac{0.002}{t}) \tan\delta \text{ (Typical)}$$

f is measurement frequency [GHz]

t is thickness of MUT [mm]

ϵ_{rm}' is measured value of ϵ_r'

$\tan\delta$ is measured value of dielectric loss tangent

Option 002 Material Measurement

$$\mu_r' \text{ Accuracy } \frac{\Delta\mu_{rm}'}{\mu_{rm}'} @ \tan\delta < 0.1 \dots\dots\dots 4 + \frac{25}{F\mu_{rm}'} + F\mu_{rm}' \left(1 + \frac{15}{F\mu_{rm}'}\right)^2 f^2[\%] \text{ (Typical)}$$

$$\text{Loss Tangent Accuracy of } \hat{\mu}_r' (\Delta\tan\delta) @ \tan\delta < 0.1 \dots\dots\dots E_a + E_b \text{ (Typical)}$$

Where,
 $E_a = 0.002 + \frac{0.001}{F\mu_{rm}'f} + 0.004f \text{ (Typical)}$

$$E_b = \frac{\Delta\mu_{rm}'}{\mu_{rm}'} \frac{\tan\delta}{100} \text{ (Typical)}$$

f is measurement frequency [GHz]

$$F = h \ln \frac{c}{b} \text{ [mm]}$$

- h** is the height of MUT [mm]
- b** is the inner diameter of MUT
- c** is the outer diameter of MUT
- tanδ** is the measured value of loss tangent
- μ_{rm}' is the measured value of permeability

At the following frequency points, instrument spurious characteristics could occasionally cause measurement errors to exceed specified value.

10.71 MHz	17.24 MHz	21.42 MHz	42.84 MHz
514.645 MHz	686.19333 MHz	1029.29 MHz	1327.38666 MHz

See “EMC” under “Others” in “General Characteristics.”

Option 002 Material Measurement

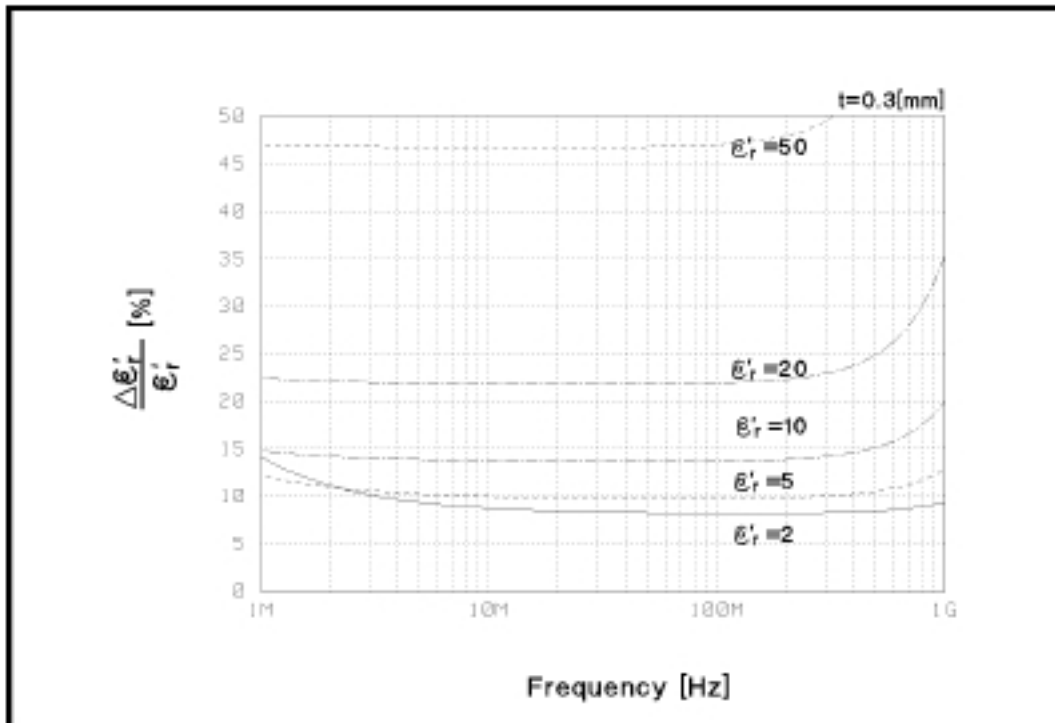

Figure 1-17. Typical Permittivity Measurement Accuracy (@ thickness = 0.3 mm)

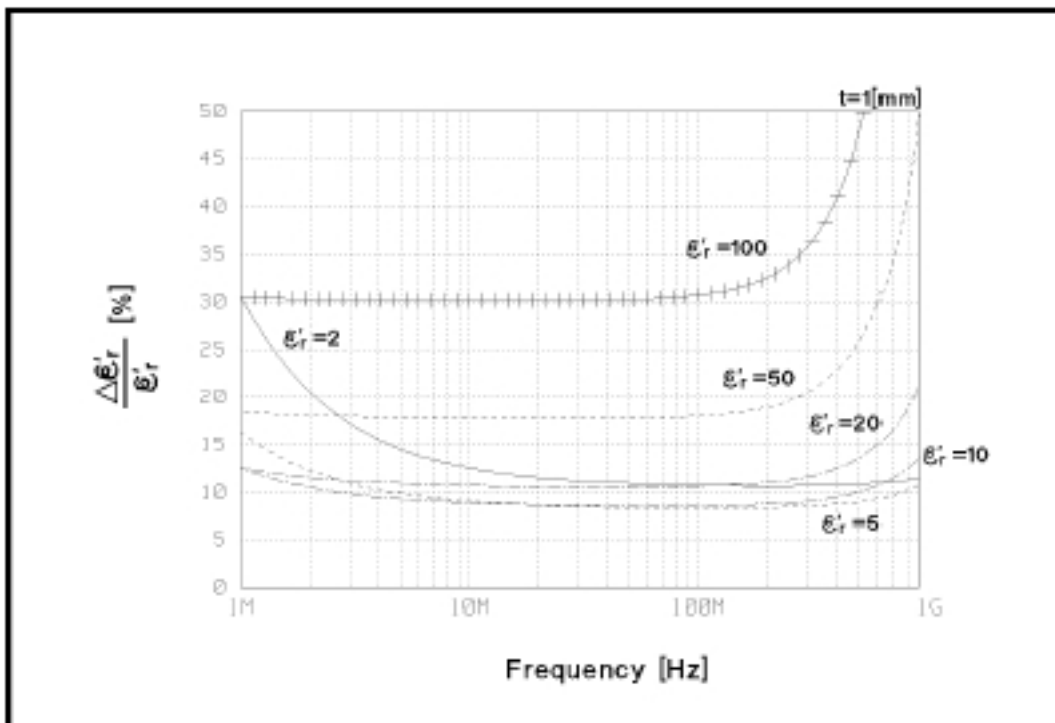

Figure 1-18. Typical Permittivity Measurement Accuracy (@ thickness = 1 mm)

Option 002 Material Measurement

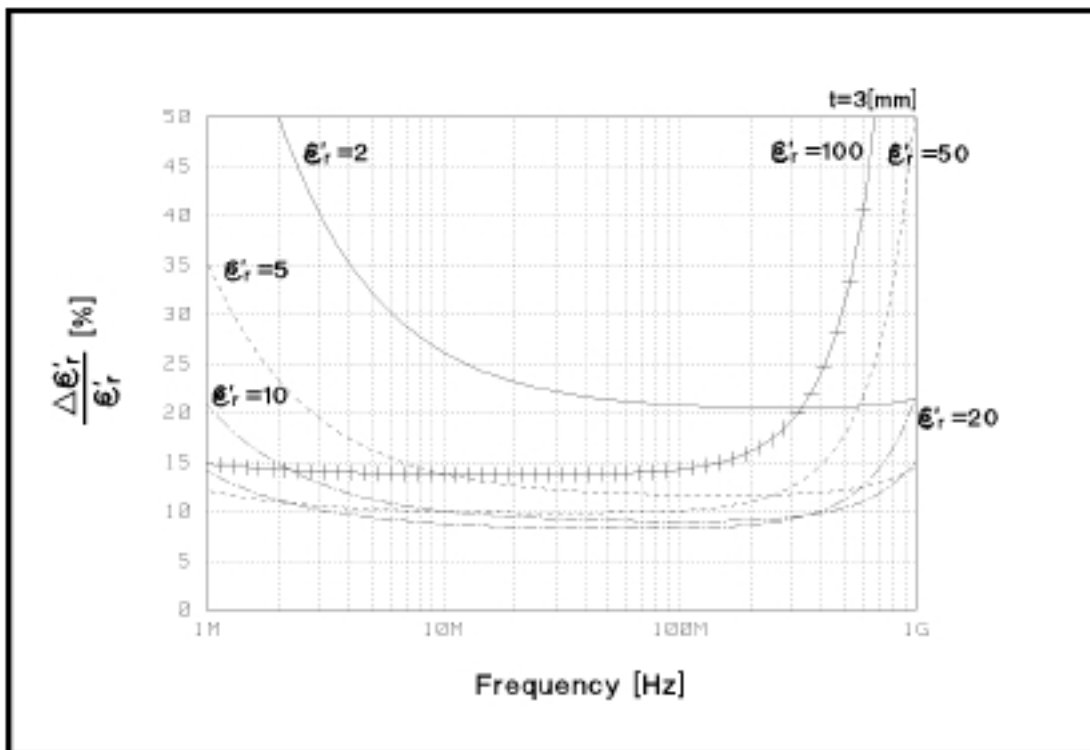

Figure 1-19. Typical Permittivity Measurement Accuracy (@ thickness = 3 mm)

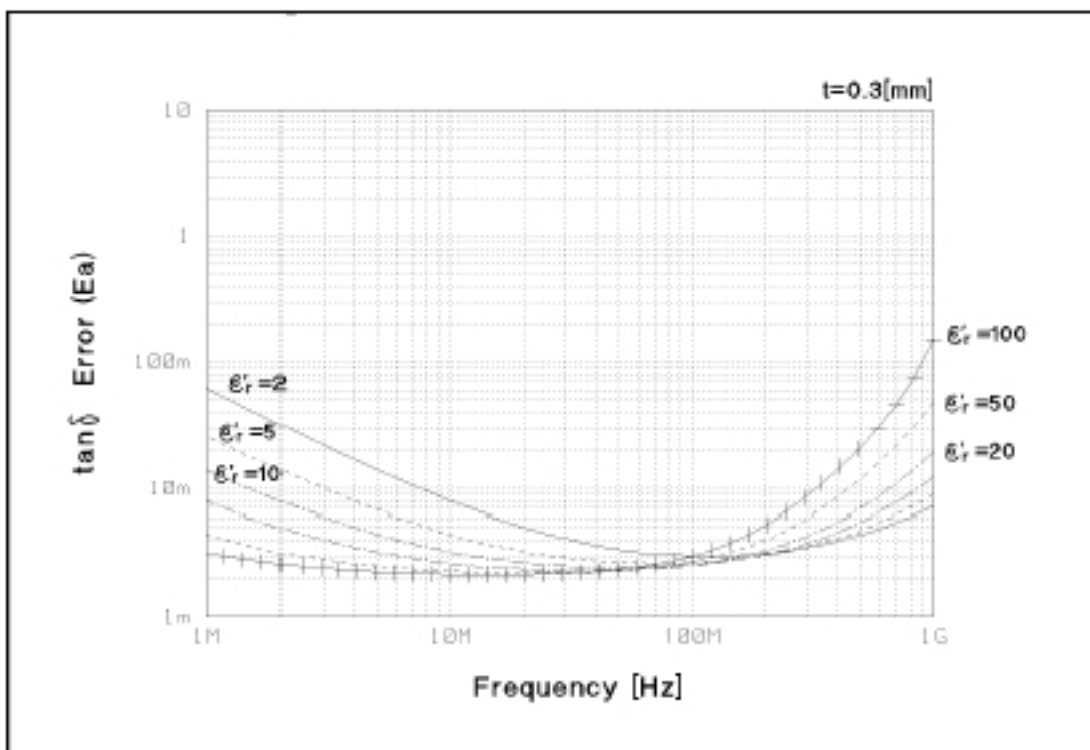

Figure 1-20. Typical Dielectric Loss Tangent ($\tan \delta$) Measurement Accuracy (@ thickness = 0.3 mm)

Option 002 Material Measurement

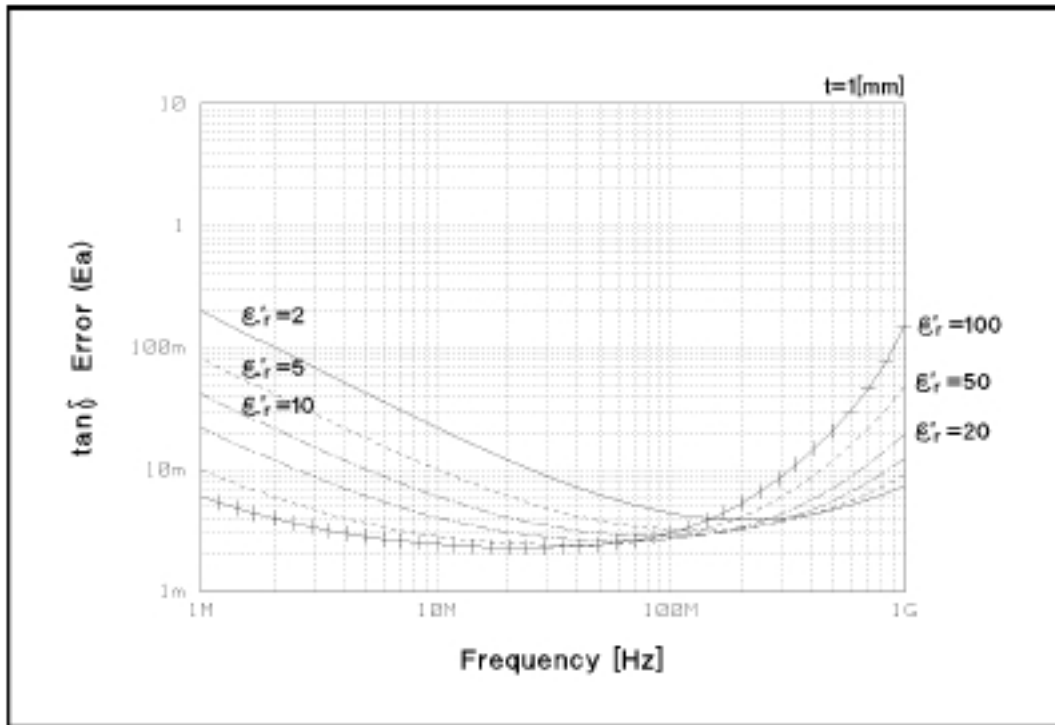

Figure 1-21. Typical Dielectric Loss Tangent ($\tan\delta$) Measurement Accuracy (@ thickness = 1 mm)

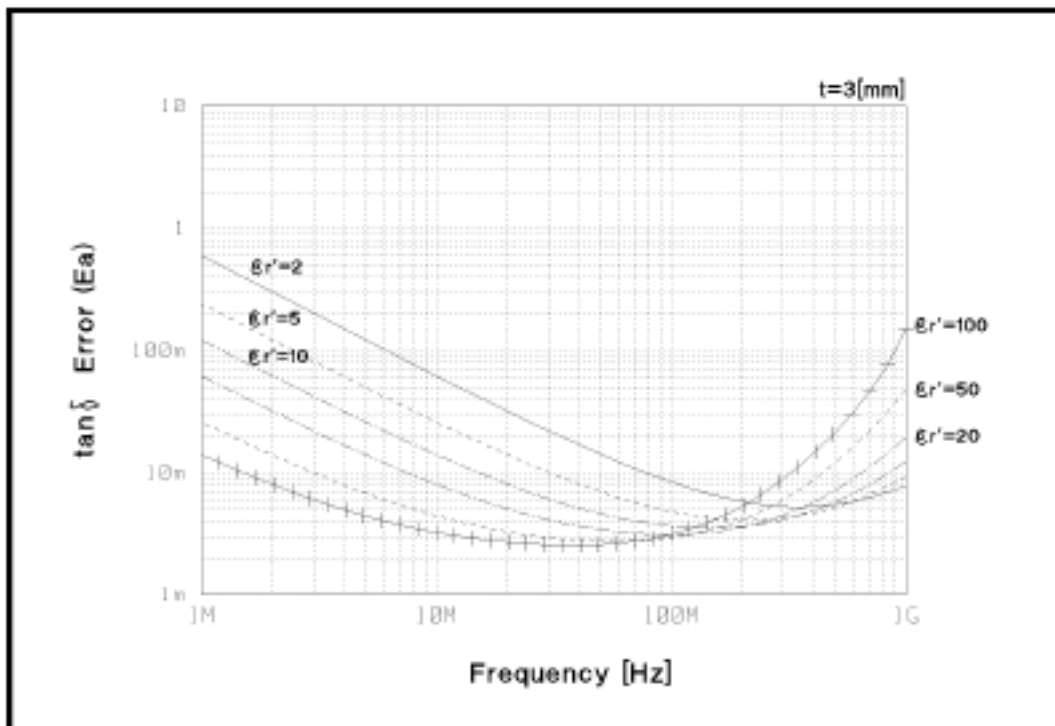

Figure 1-22. Typical Dielectric Loss Tangent ($\tan\delta$) Measurement Accuracy (@ thickness = 3 mm)

Option 002 Material Measurement

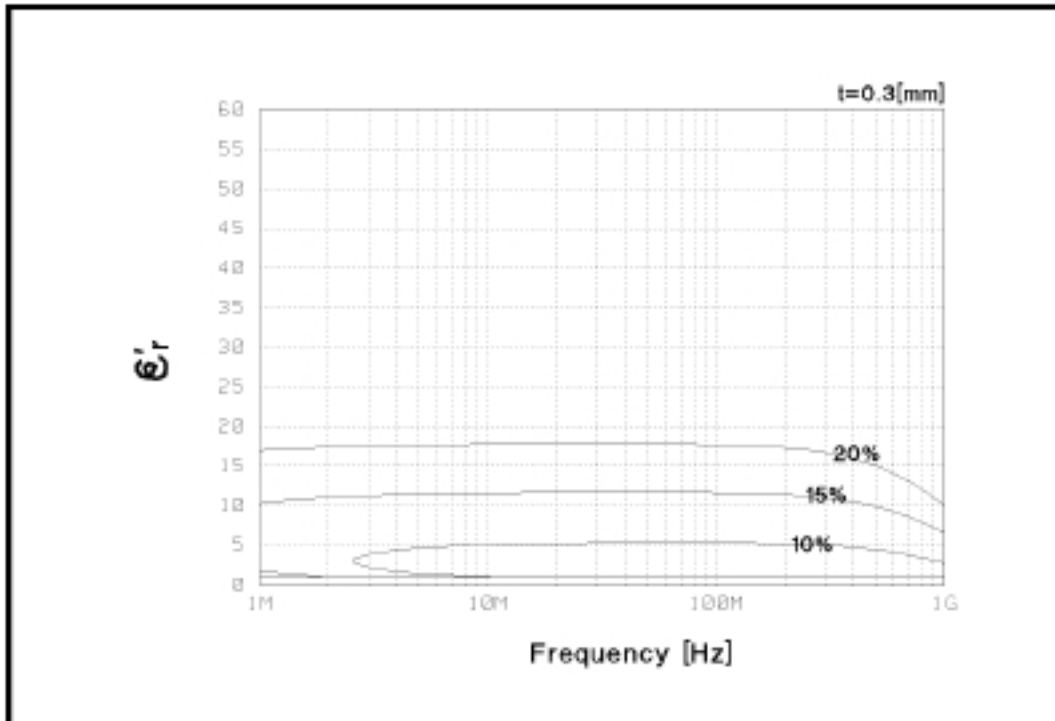

Figure 1-23. Typical Permittivity Measurement Accuracy (ϵ_r vs. Frequency, @ thickness = 0.3 mm)

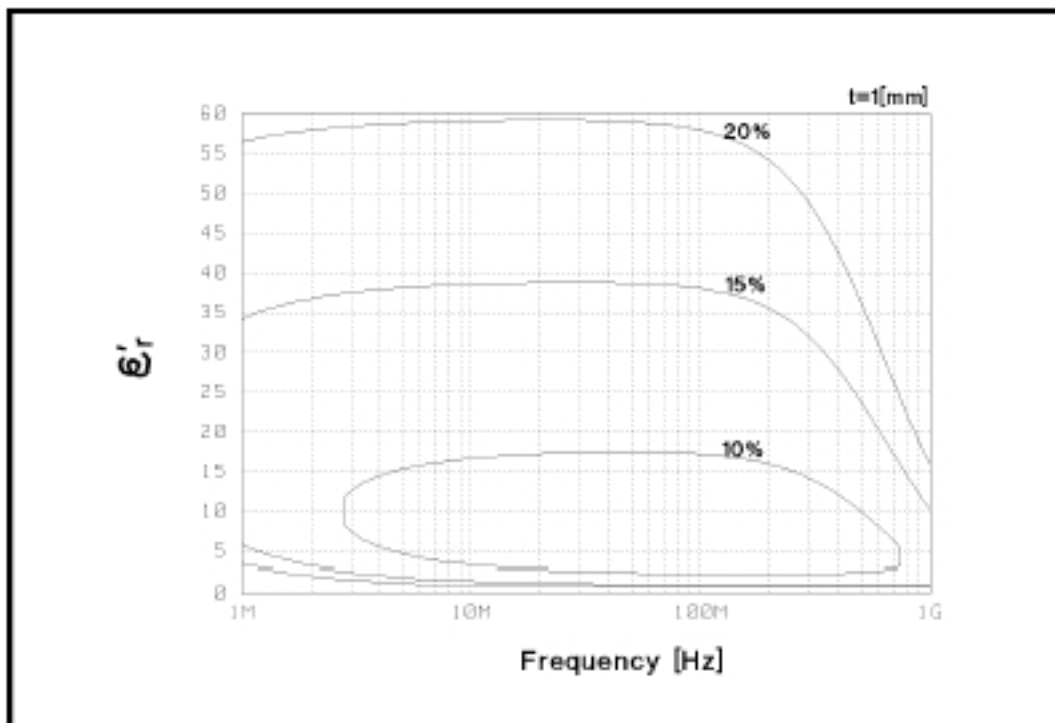

Figure 1-24. Typical Permittivity Measurement Accuracy (ϵ_r vs. Frequency, @ thickness = 1 mm)

Option 002 Material Measurement

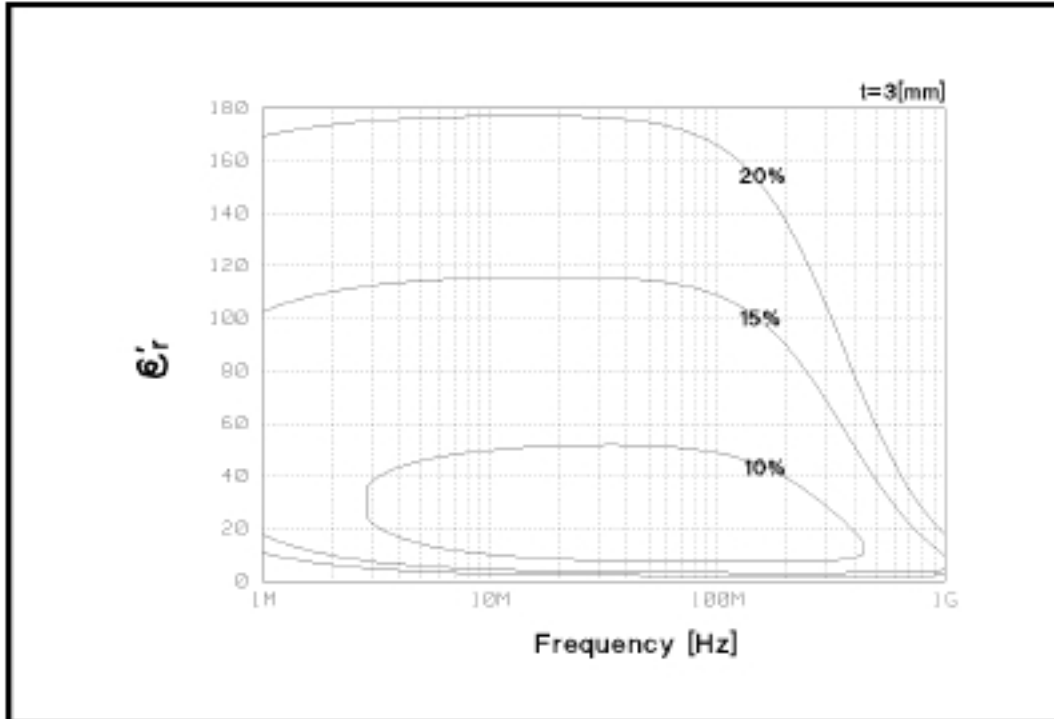

Figure 1-25. Typical Permittivity Measurement Accuracy (ϵ_r vs. Frequency, @ thickness = 3 mm)

Option 002 Material Measurement

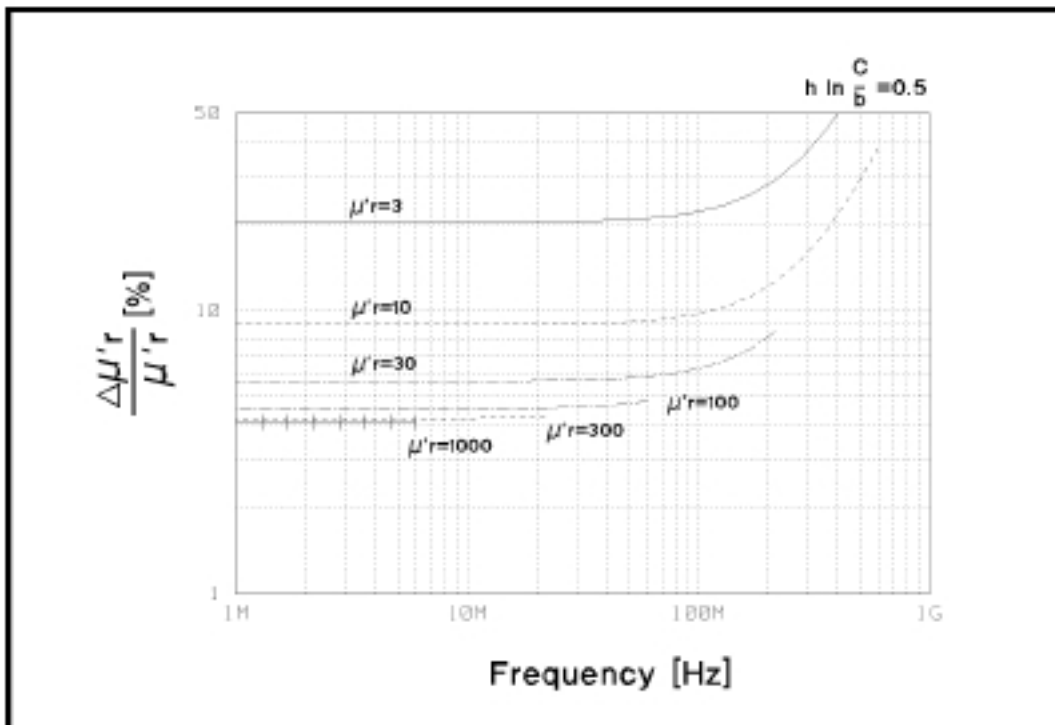

Figure 1-26. Typical Permeability Measurement Accuracy (@ $F^* = 0.5$)

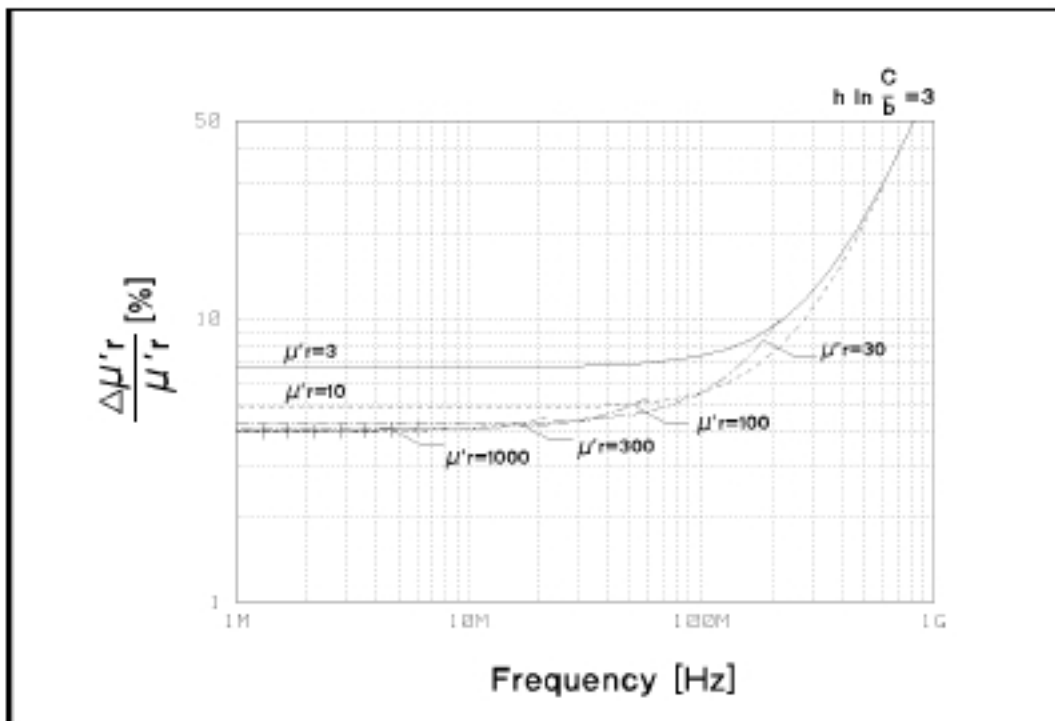

Figure 1-27. Typical Permeability Measurement Accuracy (@ $F^* = 3$) $F^* = h \ln \frac{C}{B}$

Option 002 Material Measurement

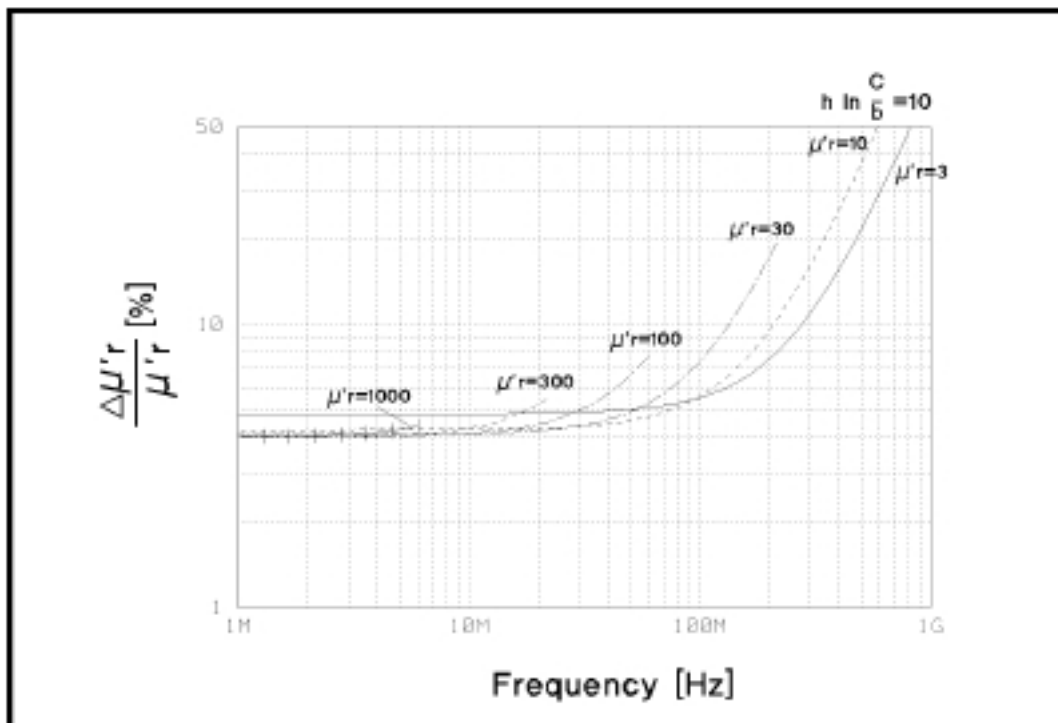

Figure 1-28. Typical Permeability Measurement Accuracy (@ $F^* = 10$)

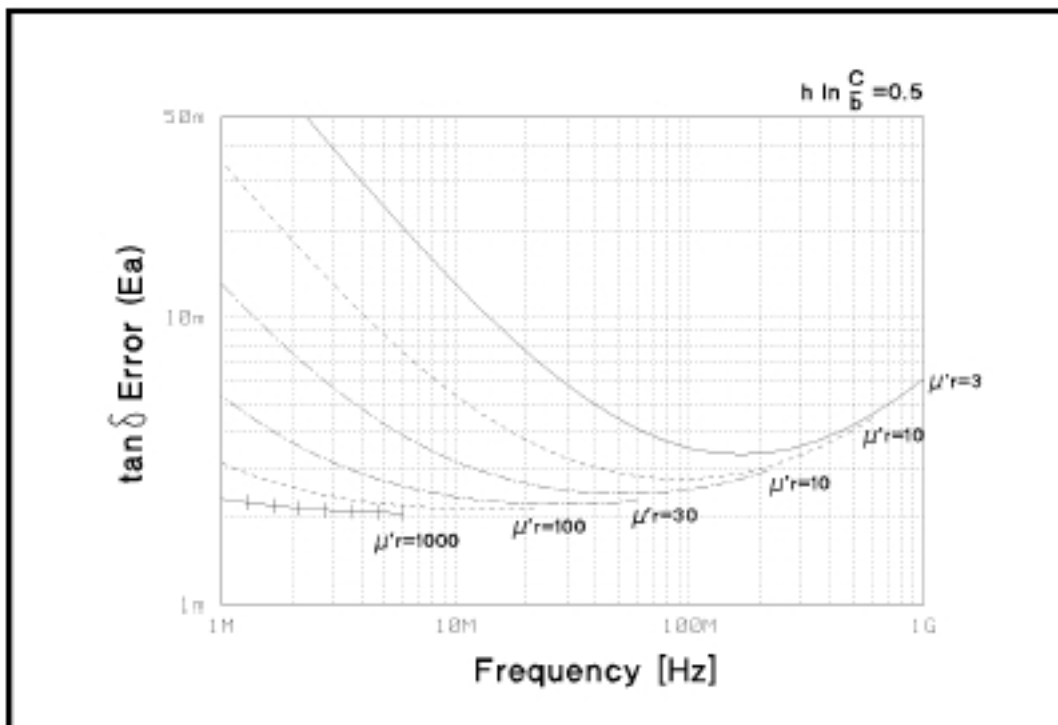

Figure 1-29. Typical Permeability Loss Tangent ($\tan \delta$) Measurement Accuracy (@ $F^* = 0.5$) $*F^* = h \ln \frac{C}{B}$

Option 002 Material Measurement

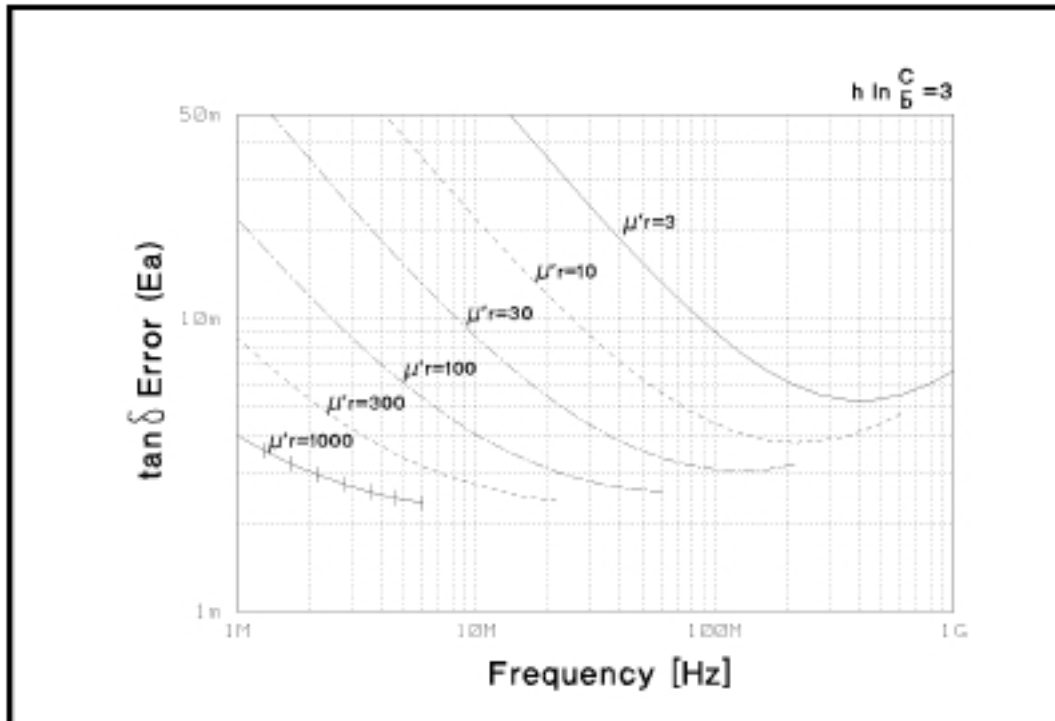

Figure 1-30. Typical Permeability Loss Tangent ($\tan \delta$) Measurement Accuracy (@ $F^* = 3$)

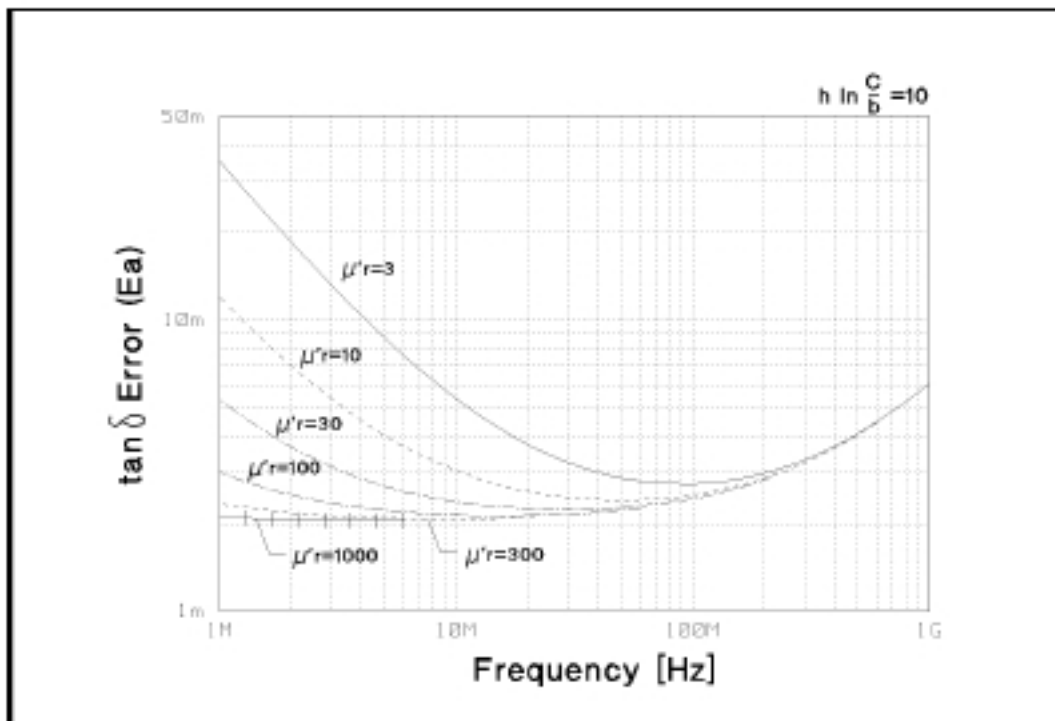

Figure 1-31. Typical Permeability Loss Tangent ($\tan \delta$) Measurement Accuracy (@ $F^* = 10$) $F^* = h \ln \frac{C}{b}$

Option 002 Material Measurement

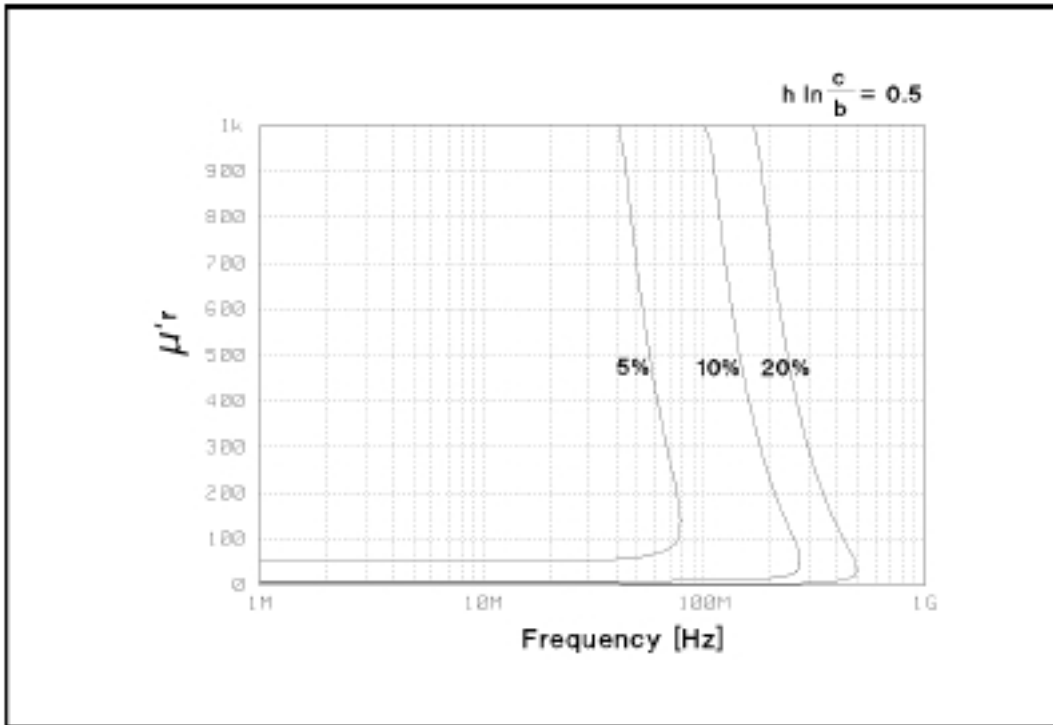

Figure 1-32. Typical Permeability Measurement Accuracy (μ_r vs. Frequency, @ $F^* = 0.5$)

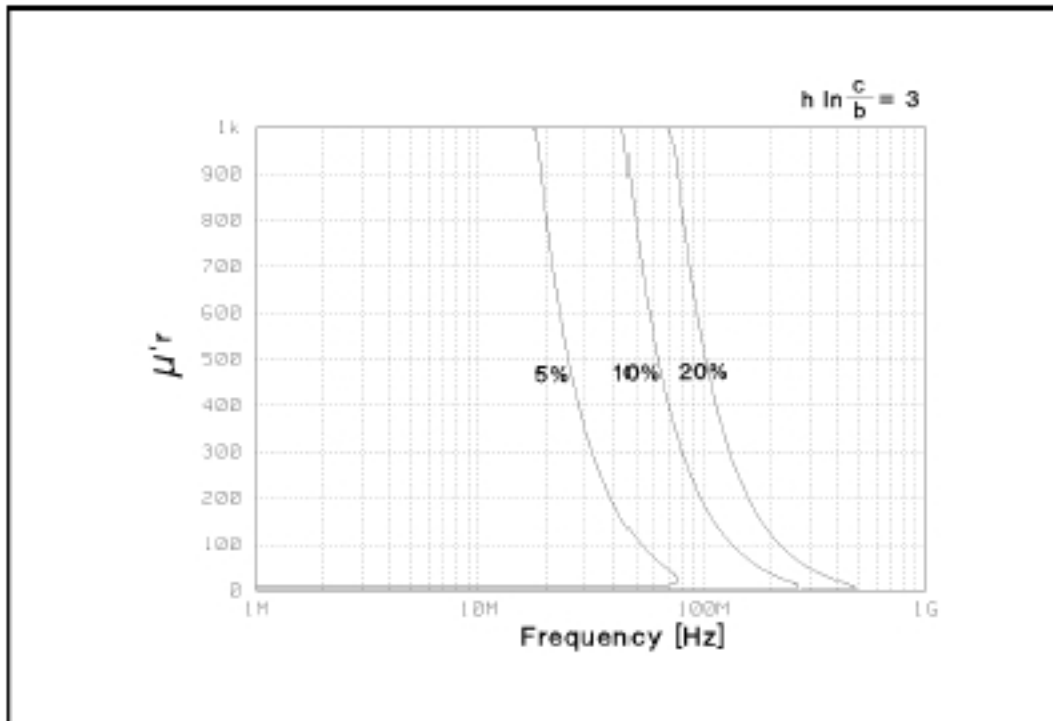

Figure 1-33. Typical Permeability Measurement Accuracy (μ_r vs. Frequency, @ $F^* = 3$) $F^* = h \ln \frac{c}{b}$

Option 002 Material Measurement

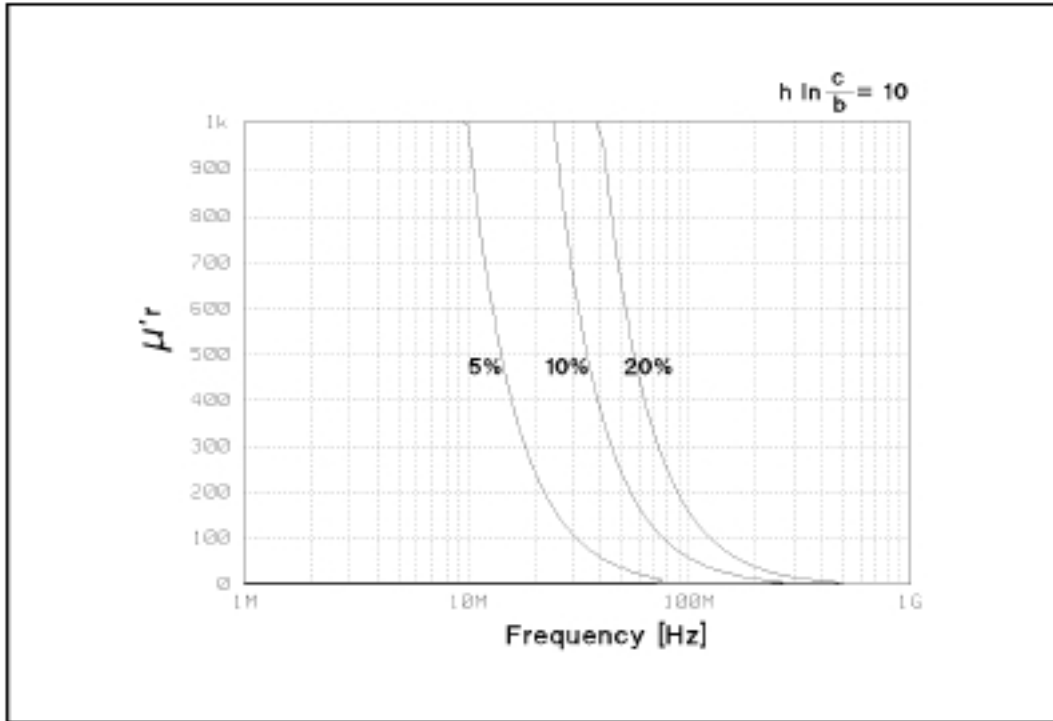

Figure 1-34. Typical Permeability Measurement Accuracy (μ_r vs. Frequency, @ $F^* = 10$) $F^* = h \ln \frac{c}{b}$

Option 002 Material Measurement

Applicable MUT (Material Under Test) Size See Tables 1-5 and 1-6

Maximum DC Bias Voltage / Current

Using the Agilent 16453A ± 40 V
 Using the Agilent 16454A ± 500 mA

Operating Temperature

Using the Agilent 16453A or 16454A -55°C to $+200^{\circ}\text{C}$

Operating Humidity

Wet bulb temperature $< 40^{\circ}\text{C}$

Using the Agilent 16453A or 16454A up to 95% RH

Table 1-5. Applicable Dielectric Material Size Using with the Agilent 16453A

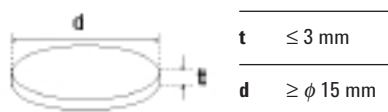
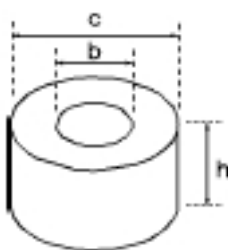

Table 1-6. Applicable Magnetic Material Size Using the Agilent 16454A



Fixture Holder	Small		Large	
	A	B	C	D
c	$\leq \phi 8$ mm	$\leq \phi 6$ mm	$\leq \phi 20$ mm	$\leq \phi 20$ mm
b	$\geq \phi 3.1$ mm	$\geq \phi 3.1$ mm	$\geq \phi 6$ mm	$\geq \phi 5$ mm
h	≤ 3 mm	≤ 3 mm	≤ 10 mm	≤ 10 mm

Material Measurement Accuracy with High Temperature Test Head

Option 002 Material Measurement Accuracy with Options 013 and 014 High Temperature Test Head (Typical)

Dielectric Material Measurement Accuracy with High Temperature Test Head (Typical)

Conditions of Dielectric Material Measurement Accuracy with High Temperature Test Head

- Environment temperature is within $\pm 5^{\circ}\text{C}$ of temperature at which calibration is done, and within 0°C to 40°C .
- High Temperature High Impedance Test Head must be used.
- Bending cable should be smooth and the bending angle less than 30° .
- Cable position should be kept in the same position after calibration measurement.
- OPEN/SHORT/ $50\ \Omega$ calibration must be done. Calibration ON.
- Measurement points are same as the calibration points.
- Averaging (on point) factor must be larger than 32 at which calibration is done.
- OSC level must be same as level at which calibration is done.
- OSC level is less than or equal to $0.25 V_{\text{rms}}$, or greater than $0.25 V_{\text{rms}}$ and frequency range is within 1 MHz to 1 GHz.
- Environment temperature of the main frame is within $\pm 5^{\circ}\text{C}$ of temperature at which calibration is done, and within 0°C to 40°C .

ϵ_r' Accuracy ($\frac{\Delta\epsilon'_{\text{rm}}}{\epsilon'_{\text{rm}}}$) Same as accuracy at which a normal test head is used

Loss Tangent Accuracy of ϵ_r'' ($\Delta\tan\delta$) Same as accuracy at which a normal test head is used

At the following frequency points, instrument spurious characteristics could occasionally cause measurement errors to exceed specified value.

10.71 MHz	17.24 MHz	21.42 MHz	42.84 MHz
514.645 MHz	686.19333 MHz	1029.29 MHz	1327.38666 MHz

See “EMC” under “Others” in “General Characteristics.”

The excessive vibration and shock could occasionally cause measurement errors to exceed specified value.

Material Measurement Accuracy with High Temperature Test Head

Typical Effects of Temperature Drift on Dielectric Material Measurement Accuracy

When environment temperature is without $\pm 5^\circ\text{C}$ of temperature at which calibration is done, add the following measurement error.

$$\epsilon_r' \text{ Accuracy } \left(\frac{\Delta \epsilon_{rm}'}{\epsilon_{rm}'} \right) \dots \dots \dots E_\epsilon + E_{a3} + E_{b3} [\%]$$

$$\text{Loss Tangent Accuracy of } \epsilon_r^A (\Delta \tan \delta) \dots \dots \dots E_{\tan \delta \epsilon} \frac{(E_{a3} + E_{b3})}{100}$$

Where,

- E_ϵ is ϵ_r' accuracy when a normal test head is used.
- $E_{\tan \delta \epsilon}$ is loss tangent accuracy when a normal test head is used.
- E_{a3} is the effect of temperature drift on the accuracy as follows:

$$E_{a3} = T_c \Delta T$$

E_{b3} is the hysteresis of the effect of temperature drift on the accuracy as follows:

$$E_{b3} = \frac{T_c \Delta T}{3}$$

Where,

T_c is temperature coefficient as follows:

$$T_c = K_1 + K_2 + K_3$$

$$K_1 = 1 \times 10^{-6} \times (50 + 300f)$$

$$K_2 = 3 \times 10^{-6} \times (4 + 50f) \left(\frac{\epsilon_{rm}'}{t} \frac{1}{|1 - (f/f_0)^2|} + 10 \right) f$$

$$K_3 = 5 \times 10^{-3} \times (0.2 + 8f^2) \frac{1}{\left(\frac{\epsilon_{rm}'}{t} \frac{1}{|1 - (f/f_0)^2|} + 10 \right) f}$$

f : Measurement Frequency [GHz]

$$f_0 = \frac{13}{\sqrt{\epsilon_{rm}'}} \text{ [GHz]}$$

t : Thickness of MUT [mm]

ϵ_{rm}' : measured value of ϵ_r'

The illustrations of temperature coefficient T_c are shown in Figures 1-35 to 1-37.

ΔT is difference of temperature between measurement condition and calibration measurement condition as follows:

$$\Delta T = |T_{meas} - T_{cal}|$$

T_{meas} : Temperature of Test Head at measurement condition

T_{cal} : Temperature of Test Head at calibration measurement condition

Material Measurement Accuracy with High Temperature Test Head

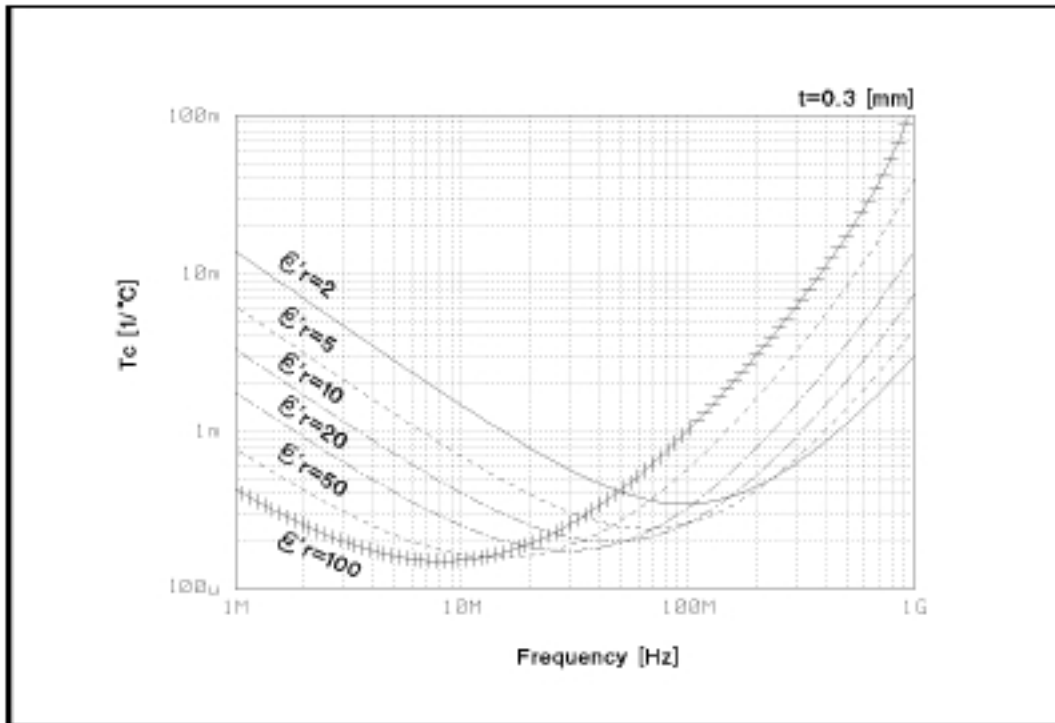

Figure 1-35. Typical Frequency Characteristics of Temperature Coefficient of ϵ_r' and Loss Tangent Accuracy (Thickness = 0.3 mm)

Material Measurement Accuracy with High Temperature Test Head

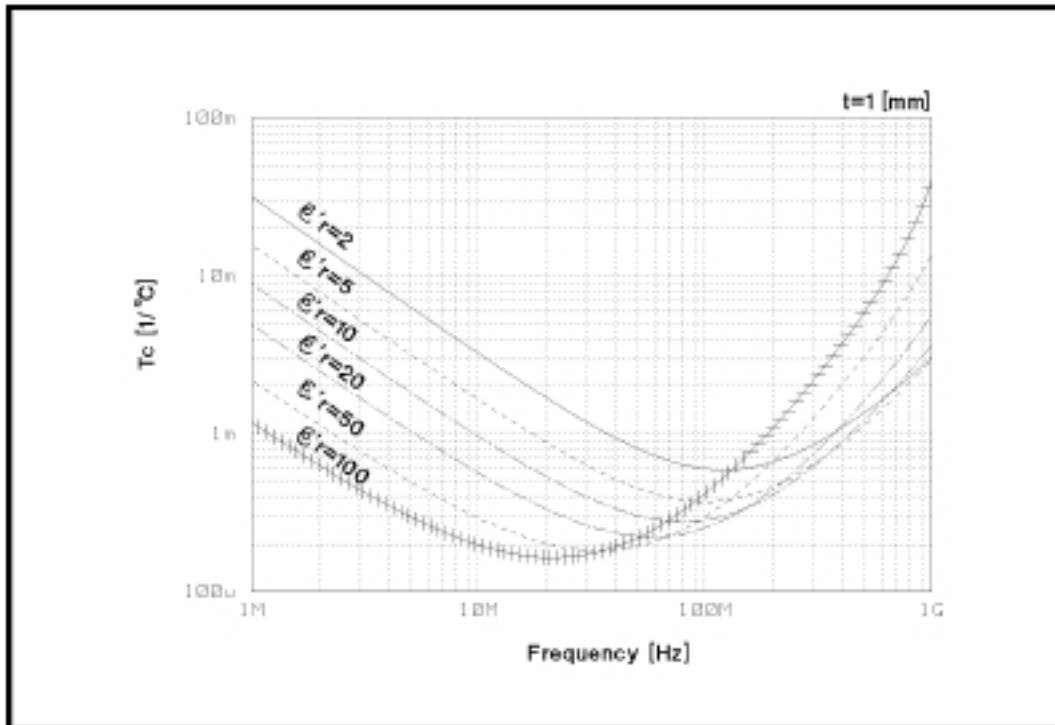

Figure 1-36. Typical Frequency Characteristics of Temperature Coefficient of ϵ_r' and Loss Tangent Accuracy (Thickness = 1 mm)

Material Measurement Accuracy with High Temperature Test Head

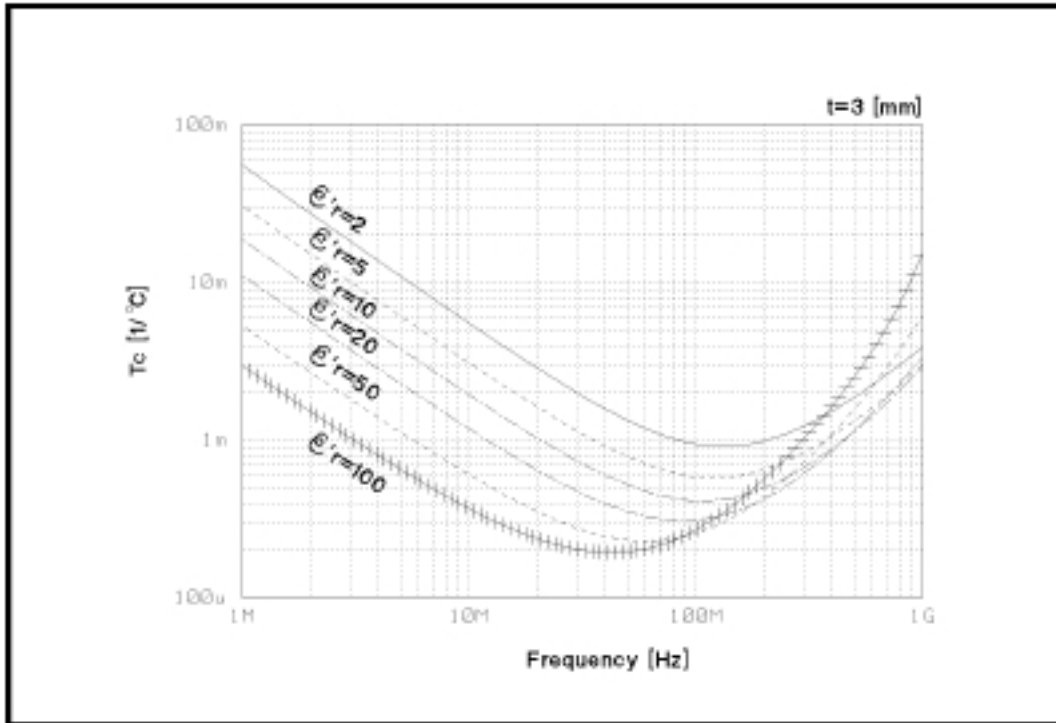

Figure 1-37. Typical Frequency Characteristics of Temperature Coefficient of ϵ_r' and Loss Tangent Accuracy (Thickness = 3 mm)

Material Measurement Accuracy with High Temperature Test Head

Material Measurement Accuracy with High Temperature Test Head (Typical)

Conditions of Dielectric Material Measurement Accuracy with High Temperature Test Head

- Environment temperature is within $\pm 5^{\circ}\text{C}$ of temperature at which calibration is done, and within 0°C to 40°C .
- High Temperature Low Impedance Test Head must be used.
- Bending cable should be smooth and the bending angle less than 30° .
- Cable position should be kept in the same position after calibration measurement.
- OPEN/SHORT/ $50\ \Omega$ calibration must be done. Calibration ON.
- Measurement points are same as the calibration points.
- Averaging (on point) factor must be larger than 32 at which calibration is done.
- OSC level must be same as level at which calibration is done.
- OSC level is less than or equal to $0.25 V_{\text{rms}}$, or greater than $0.25 V_{\text{rms}}$ and frequency range is within 1 MHz to 1 GHz.
- Environment temperature of the main frame is within $\pm 5^{\circ}\text{C}$ of temperature at which calibration is done, and within 0°C to 40°C .

μ_r' Accuracy ($\frac{\Delta\mu_r'}{\mu_r'}$) Same as accuracy at which a normal test head is used

Loss Tangent Accuracy of $\mu_r'(\Delta\tan\delta)$ Same as accuracy at which a normal test head is used

At the following frequency points, instrument spurious characteristics could occasionally cause measurement errors to exceed specified value.

10.71 MHz	17.24 MHz	21.42 MHz	42.84 MHz
514.645 MHz	686.19333 MHz	1029.29 MHz	1327.38666 MHz

See “EMC” under “Others” in “General Characteristics.”

The excessive vibration and shock could occasionally cause measurement errors to exceed specified value.

Material Measurement Accuracy with High Temperature Test Head

Typical Effects of Temperature Drift on Magnetic Material Measurement Accuracy

When environment temperature exceeds $\pm 5^\circ\text{C}$ of temperature at which calibration is done, add the following measurement error.

$$\mu_r' \text{ Accuracy } \left(\frac{\Delta \mu_{rm}'}{\mu_{rm}'} \right) \dots\dots\dots E_\mu + E_{a3} + E_{b3}$$

$$\text{Loss Tangent Accuracy of } \mu_r'(\Delta \tan \delta) \dots\dots\dots E_{\tan \delta \mu} + \frac{(E_{a3} + E_{b3})}{100}$$

Where,

- E_μ is μ_r' accuracy when a normal test head is used.
- $E_{\tan \delta \mu}$ is loss tangent accuracy when a normal test head is used.
- E_{a3} is the effect of temperature drift on the accuracy as follows:

$$E_{a3} = T_c \Delta T$$

* E_{b3} is the hysteresis of the effect of temperature drift on the accuracy as follows:

$$E_{b3} = \frac{T_c \Delta T}{3}$$

Where,

T_c is temperature coefficient as follows:

$$T_c = K_1 + K_2 + K_3$$

$$K_1 = 1 \times 10^{-6} \times (50 + 300f)$$

$$K_2 = 1 \times 10^{-2} \times (1 + 10f^2) \frac{|1 - 0.01\{F(\mu_{rm}' - 1) + 10\}f^2|}{\{F(\mu_{rm}' - 1) + 20\}f} + 10)f$$

$$K_3 = 2 \times 10^{-6} \times (1 + 30f) \frac{\{F(\mu_{rm}' - 1) + 20\}f}{|1 - 0.01\{F(\mu_{rm}' - 1) + 10\}f^2|}$$

f : Measurement Frequency [GHz]

$$F = \frac{h \ln \frac{c}{b}}{b}$$

- h is the height of MUT [mm]
- b is the inner diameter of MUT
- c is the outer diameter of MUT
- μ_{rm}' is the measured value of permeability

The illustrations of temperature coefficient T_c are shown in Figures 1-38 to 1-40.

ΔT is difference of temperature between measurement condition and calibration measurement condition as follows:

$$\Delta T = |T_{\text{meas}} - T_{\text{cal}}|$$

- T_{meas} : Temperature of Test Head at measurement condition
- T_{cal} : Temperature of Test Head at calibration measurement condition

Material Measurement Accuracy with High Temperature Test Head

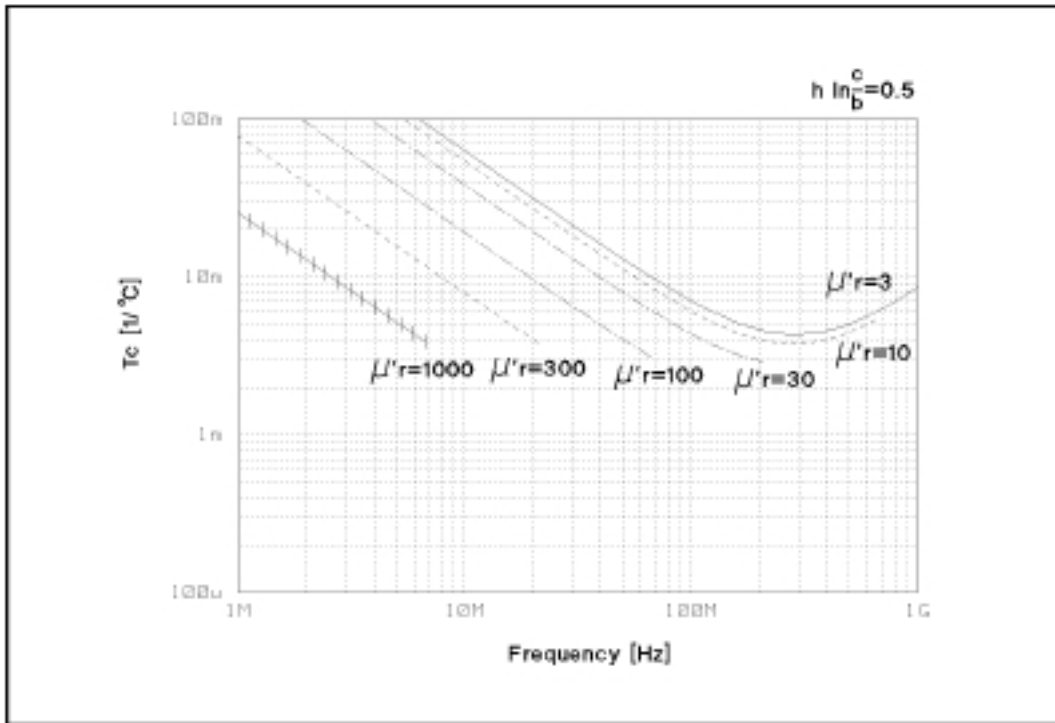

Figure 1-38. Typical Frequency Characteristics of Temperature Coefficient of μ'_r and Loss Tangent Accuracy ($F^* = 0.5$)

$$*F^* = h \ln \frac{c}{b}$$

Material Measurement Accuracy with High Temperature Test Head

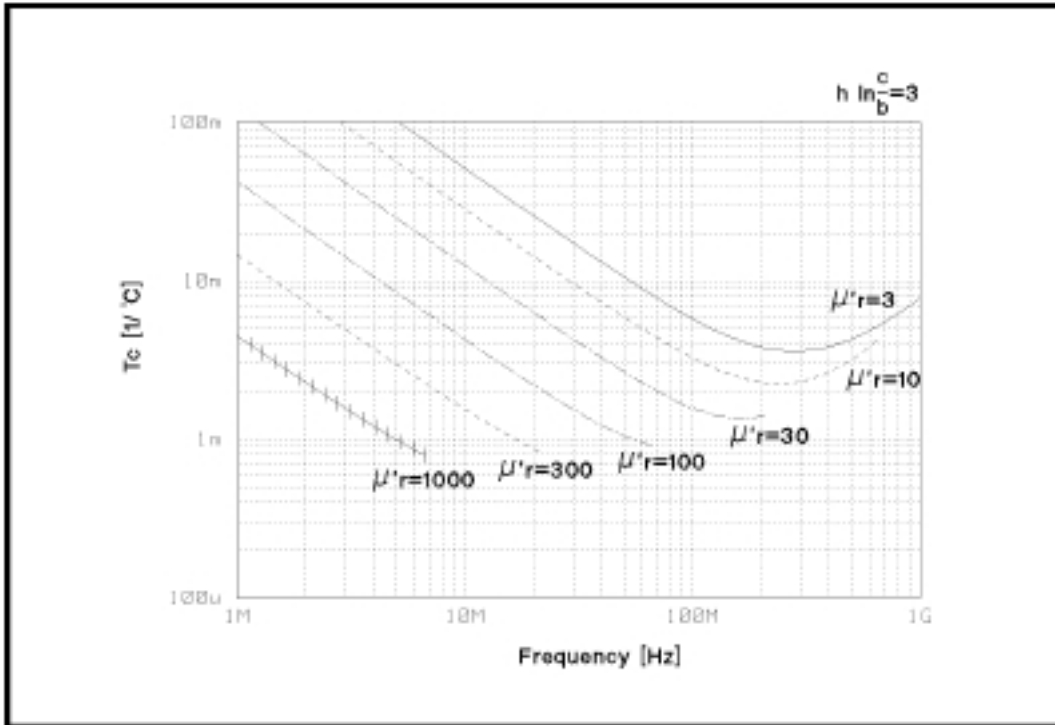

Figure 1-39. Typical Frequency Characteristics of Temperature Coefficient of μ'_r and Loss Tangent Accuracy ($F^* = 3$)

$$F^* = h \ln \frac{c}{b}$$

Material Measurement Accuracy with High Temperature Test Head

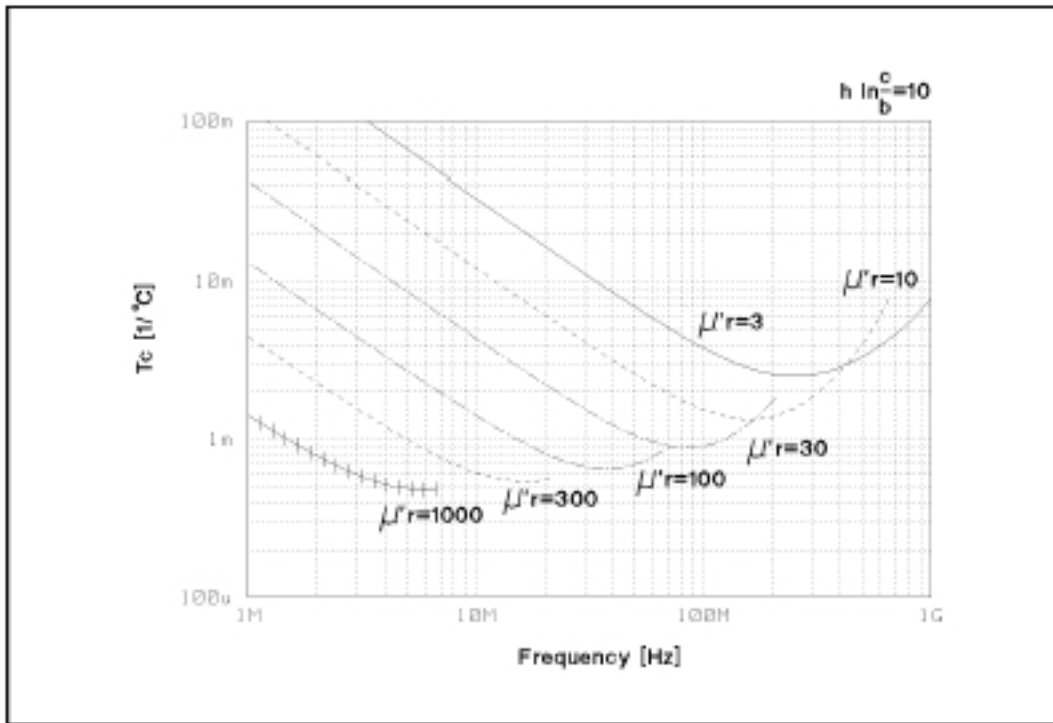

Figure 1-40. Typical Frequency Characteristics of Temperature Coefficient of μ_r' and Loss Tangent Accuracy ($F^* = 10$)

$$F^* = h \ln \frac{c}{b}$$

Furnished Accessories

Accessory	Agilent part number
Operating Manual	04291-90020
Programming Manual	04291-90027
Service Manual ¹	04291-90111
Program Disk Set	04291-18000
Power Cable ²	
50 Ω Termination	04291-65006
0 Ω Termination	04191-85300
0 S Termination	04191-85302
Low-Loss Capacitor	04291-60042
Calibration Kit Carrying Case	04291-60041
APC-7 End Cap	16190-25011
Fixture Stand ³	04291-60121
Pad	04291-09001
BNC Adapter ⁴	1250-1859
Mini-DIN Keyboard	C3757-60401
Instrument BASIC User's Handbook	E2083-90000
Handle Kit ⁵	5062-3991
Rack Mount Kit ⁶	5062-3979
Rack Mount and Handle Kit ⁷	5062-3985

1. Option OBW only

2. The power cable depends on where the instrument is used; see User's Guide.

3. Option 013 and 014 only

4. Option 1D5 only

5. Option 1CN only

6. Option 1CM only

7. Option 1CP only

 **Agilent Email Updates**

www.agilent.com/find/emailupdates

Get the latest information on the products and applications you select.

 **Agilent Direct**

www.agilent.com/find/agilentdirect

Quickly choose and use your test equipment solutions with confidence.

**Agilent
Open** 

www.agilent.com/find/open

Agilent Open simplifies the process of connecting and programming test systems to help engineers design, validate and manufacture electronic products. Agilent offers open connectivity for a broad range of system-ready instruments, open industry software, PC-standard I/O and global support, which are combined to more easily integrate test system development.

www.agilent.com**Agilent Technologies' Test and Measurement Support, Services, and Assistance**

Agilent Technologies aims to maximize the value you receive, while minimizing your risk and problems. We strive to ensure that you get the test and measurement capabilities you paid for and obtain the support you need. Our extensive support resources and services can help you choose the right Agilent products for your applications and apply them successfully. Every instrument and system we sell has a global warranty. Two concepts underlie Agilent's overall support policy: "Our Promise" and "Your Advantage."

Our Promise

Our Promise means your Agilent test and measurement equipment will meet its advertised performance and functionality. When you are choosing new equipment, we will help you with product information, including realistic performance specifications and practical recommendations from experienced test engineers. When you receive your new Agilent equipment, we can help verify that it works properly and help with initial product operation.

Your Advantage

Your Advantage means that Agilent offers a wide range of additional expert test and measurement services, which you can purchase according to your unique technical and business needs. Solve problems efficiently and gain a competitive edge by contracting with us for calibration, extra-cost upgrades, out-of-warranty repairs, and onsite education and training, as well as design, system integration, project management, and other professional engineering services. Experienced Agilent engineers and technicians worldwide can help you maximize your productivity, optimize the return on investment of your Agilent instruments and systems, and obtain dependable measurement accuracy for the life of those products.

United States:

(tel) 800 829 4444

(fax) 800 829 4433

Canada:

(tel) 877 894 4414

(fax) 800 746 4866

China:

(tel) 800 810 0189

(fax) 800 820 2816

Europe:

(tel) 31 20 547 2111

Japan:

(tel) (81) 426 56 7832

(fax) (81) 426 56 7840

Korea:

(tel) (080) 769 0800

(fax) (080) 769 0900

Latin America:

(tel) (305) 269 7500

Taiwan:

(tel) 0800 047 866

(fax) 0800 286 331

Other Asia Pacific**Countries:**

(tel) (65) 6375 8100

(fax) (65) 6755 0042

Email: tm_ap@agilent.com

Contacts revised: 09/28/05

For more information on Agilent Technologies' products, applications or services, please contact your local Agilent office. The complete list is available at:

www.agilent.com/find/contactus

Product specifications and descriptions in this document subject to change without notice.

© Agilent Technologies, Inc. 1997, 2000, 2006

Printed in USA, July 13, 2006

5966-1543E

**Agilent Technologies**